

Comhairle Contae Chorcaí Cork County Council

David O'Keeffe,
Ballinvuskig West,
Mourneabbey,
Co. Cork.
P51 T6TO

6th November, 2024

REF: D/263/24
LOCATION: Ballinvuskig West, Mourneabbey, Co. Cork.

**RE: DECLARATION OF EXEMPTED DEVELOPMENT UNDER SECTION 5 OF THE
PLANNING & DEVELOPMENT ACT 2000 - 2010.**

Dear Sir,

On the basis of the information submitted by you on 16th September and 24th October, 2024 the Planning Authority, having considered whether the construction of a dry shed for the storage of hay to feed sheep in winter months at **Ballinvuskig West, Mourneabbey, Co. Cork** is or is not development or is or is not exempted development, has declared that it is **exempted development**.

Reason for Decision

The Planning Authority in considering this referral, had particular regard to:

- Sections 2, 3 and 4 of the Planning and Development Act 2000 (as amended)
- Articles 6 and 9 of the Planning and Development Regulations, 2001, as amended
- Class 9 of Part 3 of Schedule 2 of the Planning and Development Regulations (2001), as amended
- The nature, extent and scope of the development outlined in the documentation submitted.

And Whereas the Planning Authority hereby concludes that

The construction of the proposed dry shed for the storage of hay at **Ballinvuskig West, Mourneabbey, Co. Cork** constitutes **development and is exempted development**.

This exemption does NOT itself empower a person to carry out a development unless that person is legally entitled to do so.

Please note that under Section 5 Subsection 3(a) where a declaration is issued under this section, any person issued with a declaration under subsection 2(a) may, on payment to

Pleanáil agus Forbairt,
Halla an Chontae,
Bóthar Charraig Ruacháin,
Corcaigh T12 R2NC.

Fón: (021) 4276891
R-phost: planninginfo@corkcoco.ie
Suíomh Gréasáin: www.corkcoco.ie

Planning & Development,
County Hall,
Carrigrohane Road, Cork T12 R2NC.

Tel (021) 4276891
Email: planninginfo@corkcoco.ie
Web: www.corkcoco.ie



the Board of such fee as may be prescribed, refer a declaration for review by the Board within 4 weeks of the date of the issuing of the declaration.

Yours faithfully,



**PIO TREACY,
ADMINISTRATIVE OFFICER,
PLANNING DEPARTMENT.**

In order to process your query, it may be necessary for Cork County Council to collect Personal information from you. Such information will be processed in line with our privacy statement which is available to view at <https://www.corkcoco.ie/privacy-statement-cork-county-council>

SECTION 5 DECLARATION – PLANNER’S REPORT

File Reference: D/263/24
Description: Dry shed for the storage of hay to feed sheep in the winter months.
Applicant: David O’Keeffe
Location: Ballinvustig West, Moourneabbey, Co. Cork
Date: 06/11/2024

SUMMARY OF RECOMMENDATION

IS EXEMPTED DEVELOPMENT

This report should be read in conjunction with the previous report on file dated 10/10/2024.

Assessment of FI Response

The applicant has confirmed all steel will be olive in colour painted from manufacturer, tile style roof, double glazed windows, insulated doors and roof will have gutters. Based on the information provided I am satisfied the proposed development complies with the criteria of Class 9 of Part 3, Schedule 2 of the Planning and Development Regulations.

Conclusion

Is Exempted Development

Recommendation

WHEREAS a question has arisen as to:

Whether the construction of a dry shed for the storage of hay at Ballinvustig West, Mourneabbey, Co. Cork is development and is or is not exempted development?

AND WHEREAS Cork County Council, in considering this referral, had regard particularly to –

- (a) Sections 2, 3 and 4 of the Planning and Development Act, 2000, as amended
- (b) Articles 6 and 9 of the Planning and Development Regulations 2001 (as amended),
- (c) Class 9 of Part 3 of Schedule 2 of the Planning and Development Regulations (2001), as amended,
- (d) The nature, extent and scope of the development outlined in the documentation submitted,

AND WHEREAS Cork County Council has concluded that the proposed dry shed for the storage of hay is exempted development.

NOW THEREFORE, Cork County Council, in exercise of the powers conferred on it by Section 5 of the 2000 Act, hereby decides that the said development is exempted development.

Louise Ahern

Louise Ahern
A/Senior Executive Planner
06/11/2024

D/263/24 – FI RESPONSE

I've attached a drawing with this email of hay barn ,this drawing was in application i submitted I'm sure ,but you can double check ,don't have copy myself .

Steeltech sheds are ce mark approved,

Galvanised frame ,20 year guarantee, tile style roof,insulated steel sheets ,all steel will be olive in colour painted from manufacturer, windows double glazed, insulated doors ,roof will have cutters to catch the water redirect away from building,

Size of hay barn is well under exemption limits too see drawings

Further information D/263/24

The hay barn is 20 metres long by 6 metres in width ,well under the limits of exemption.

I'll be getting a shed company in to erect the hay barn ,from speaking with them it will be a insulated steel shed ,all finishes a shed green paint to blend in with the farm environment ,roof is the same .

I'm too get a local company steel tech to erect sheds ,I can ask my rep their if you want more details with any of the finish materials etc.

KEY PLAN WITH NORTH POINT



	RCC WORK
	BRICK WORK
	POROTHERM WALL
	SOLID CONCRETE BLOCK WORK
	AAC BLOCK WORK

AREA STATEMENT

SITE AREA	: XXXX.XXX SQM	
DESCRIPTION	FSI AREA (IN SQM)	NON FSI (IN SQM)
Ground Floor		
First Floor		
Total Area		
FSI		
PLOT COVERAGE (%)		

JOINERY SCHEDULE

TYPE	DESCRIPTION	SILL	LINTEL	SIZE
MD	Main Door	-	2400	1200 X 2400
KW	Kitchen Window	1050	2400	1500 X 1350

FOR SPECIAL NOTES

R.NO	DESCRIPTION	DATE
1	Entrance gate relocated	23-05

REVISIONS

SIGN & SEAL WITH MARKS

NAME	: XXXX
REG. NO.	: XXXX
CLASS	: XXXX
PROJECT NAME	: XXXX
LOCATION	: XXXX

DRAWING TITLE	CONCEPT DRAWING
	GROUND FLOOR PLAN

SIGNATURE	
DATE : XX.XX.XXXX	
SCALE : 1 : 500 A2	SHEET NO. : 01



SITE

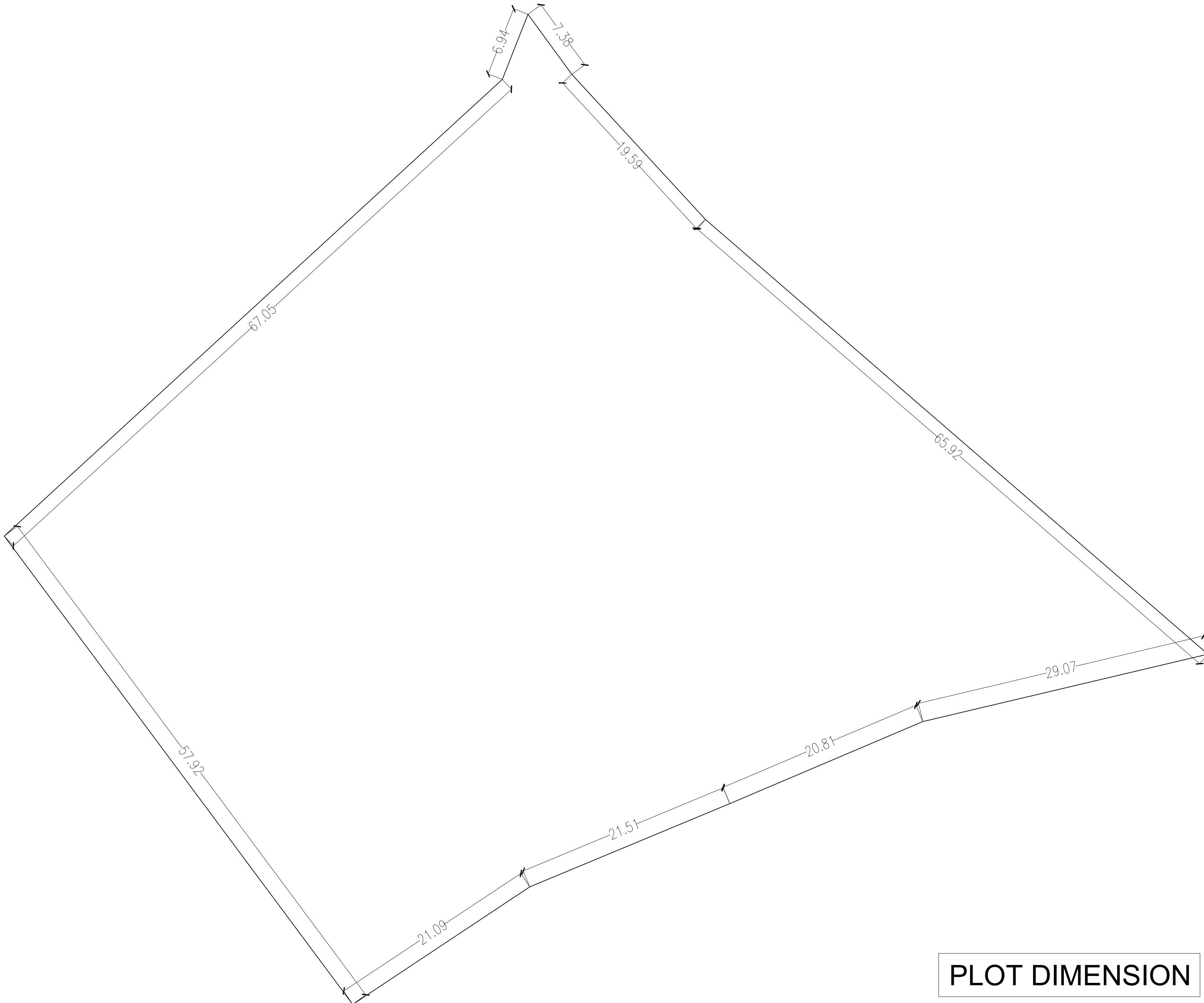

PLOT DIMENSION

- RCC WORK
- BRICK WORK
- POROTHERM WALL
- SOLID CONCRETE BLOCK WORK
- AAC BLOCK WORK

AREA STATEMENT

SITE AREA	: XXXX.XXX SQM	
DESCRIPTION	FSI AREA (IN SQM)	NON FSI (IN SQM)
GROUND FLOOR		
FIRST FLOOR		
TOTAL AREA		
FSI		
PLOT COVERAGE (%)		

JOINERY SCHEDULE

TYPE	DESCRIPTION	SILL	LINTEL	SIZE
MD	MAIN DOOR	-	2400	1200 X 2400
KW	KITCHEN WINDOW	1050	2400	1500 X 1350

FOR SPECIAL NOTES

1	ENTRANCE GATE RELOCATED TO SOUTH EAST	23-05-2017
R.NO	DESCRIPTION	DATE
1	REVISIONS	

SIGN & SEAL

DRAWN BY : XXXX
 DRAWN BY : XXXX
 PROJECT : SHED
 LOCATION : XXXX
 DRAWING TITLE : Shed Floor Plan

SIGN	
DATE : XX.XX.XXXX	
SCALE : 1 : 1	SHEET NO. : 01

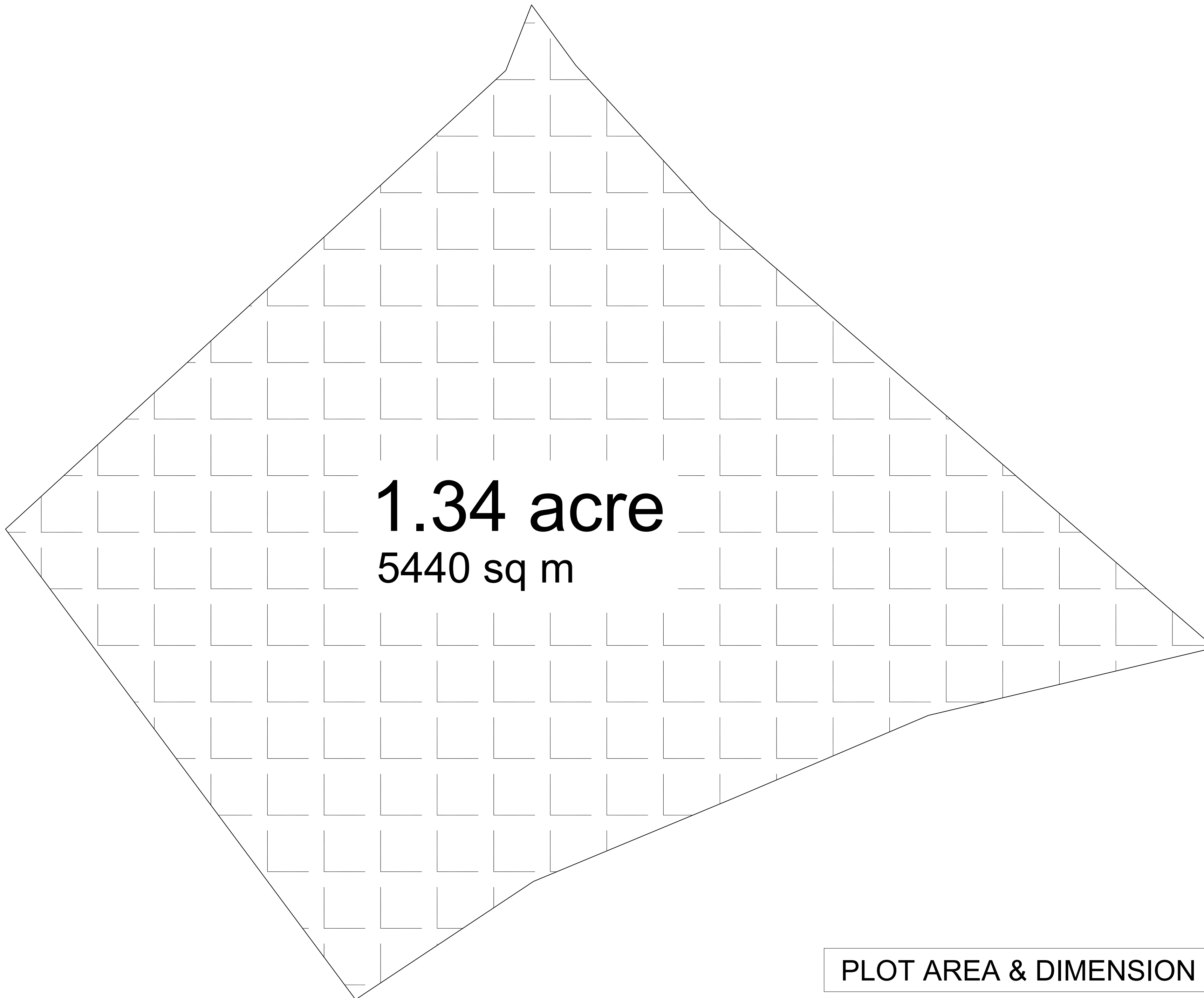

PLOT AREA & DIMENSION

- RCC WORK
- BRICK WORK
- POROTHERM WALL
- SOLID CONCRETE BLOCK WORK
- AAC BLOCK WORK

AREA STATEMENT

SITE AREA : XXXX.XXX SQM		
DESCRIPTION	FSI AREA (IN SQM)	NON FSI (IN SQM)
GROUND FLOOR		
FIRST FLOOR		
TOTAL AREA		
FSI		
PLOT COVERAGE (%)		

JOINERY SCHEDULE

TYPE	DESCRIPTION	SILL	LINTEL	SIZE
MD	MAIN DOOR	-	2400	1200 X 2400
KW	KITCHEN WINDOW	1050	2400	1500 X 1350

FOR SPECIAL NOTES

1 ENTRANCE GATE RELOCATED TO SOUTH EAST 23-05-2017

R.NO	DESCRIPTION	DATE
1	REVISIONS	

SIGN & SEAL

DRAWN BY : XXXX
 DRAWN BY : XXXX
 PROJECT : SHED
 LOCATION : XXXX

DRAWING TITLE : Shed Floor Plan

SIGN	
DATE : XX.XX.XXXX	
SCALE : 1 : 1 A2	SHEET NO. : 01

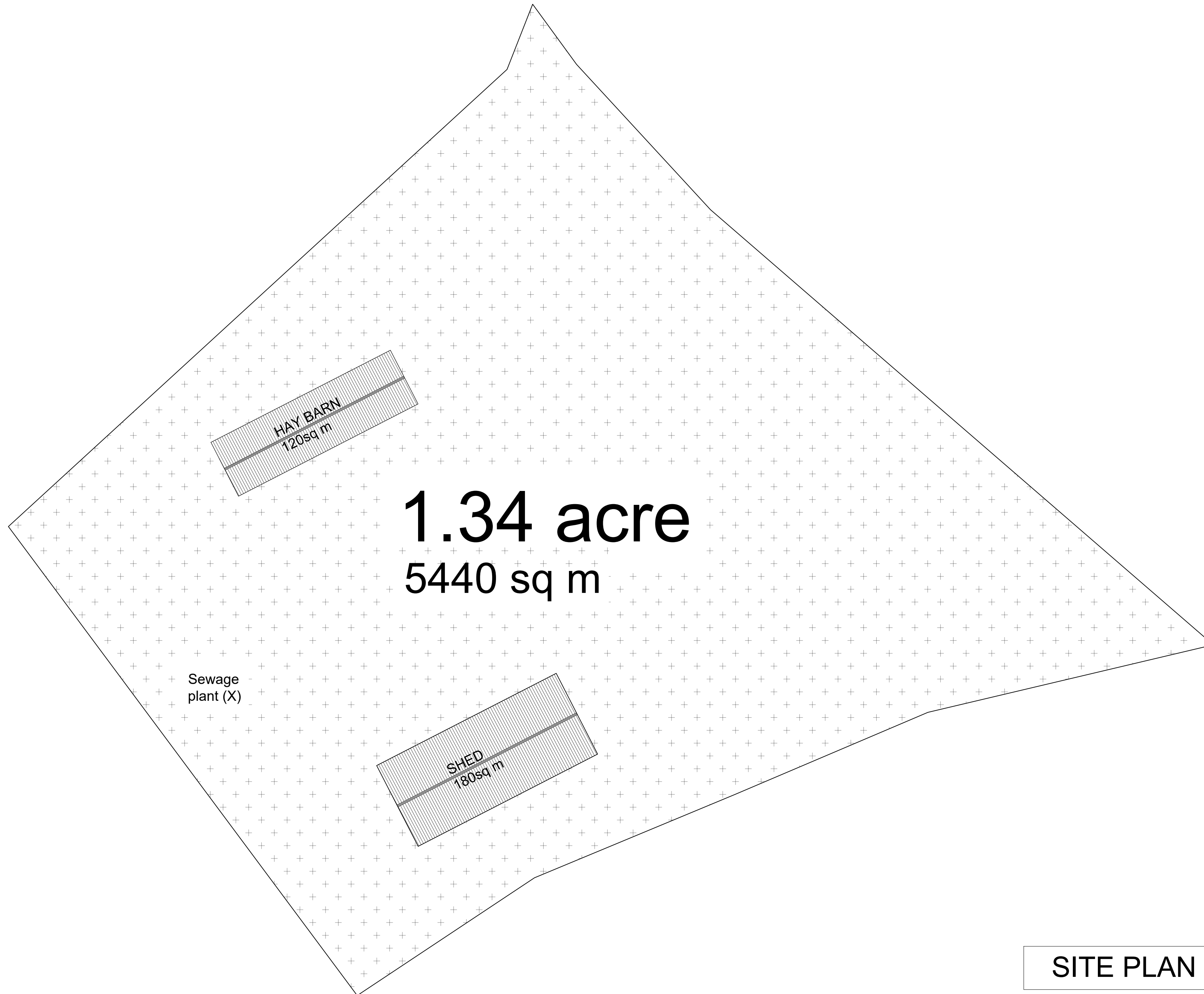

1.34 acre
5440 sq m

Sewage
plant (X)

HAY BARN
120sq m

SHED
180sq m

SITE PLAN

	RCC WORK
	BRICK WORK
	POROTHERM WALL
	SOLID CONCRETE BLOCK WORK
	AAC BLOCK WORK

AREA STATEMENT

SITE AREA	:XXXX.XXX SQM	
DESCRIPTION	FSI AREA (IN SQM)	NON FSI (IN SQM)
GROUND FLOOR		
FIRST FLOOR		
TOTAL AREA		
FSI		
PLOT COVERAGE (%)		

JOINERY SCHEDULE

TYPE	DESCRIPTION	SILL	LINTEL	SIZE
MD	MAIN DOOR	-	2400	1200 X 2400
KW	KITCHEN WINDOW	1050	2400	1500 X 1350

FOR SPECIAL
NOTES

1	ENTRANCE GATE RELOCATED TO SOUTH EAST	23-05-2017
R.NO	DESCRIPTION	DATE
1	REVISIONS	

SIGN & SEAL

DRAWN BY	: XXXX
DRAWN BY	: XXXX
PROJECT	: SHED
LOCATION	: XXXX
DRAWING TITLE	Shed Floor Plan

SIGN	
DATE	
SCALE	: 1 : 1
A2	SHEET NO. : 01

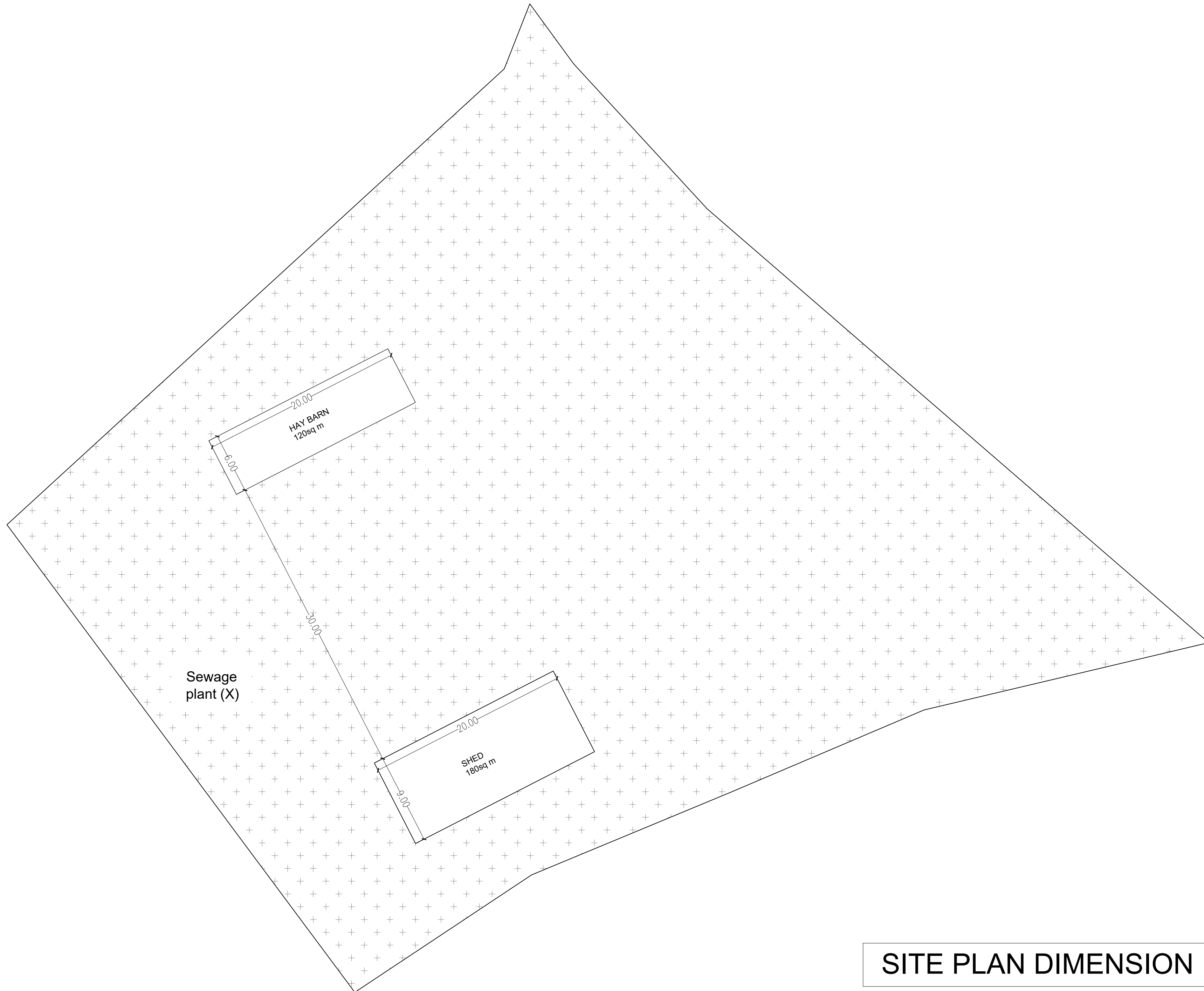

SITE PLAN DIMENSION

	RCC WORK
	BRICK WORK
	POROTHERM WALL
	SOLID CONCRETE BLOCK WORK
	AAC BLOCK WORK

AREA STATEMENT

SITE AREA	: XXXX.XXX SQM	
DESCRIPTION	FSI AREA (IN SQM)	NON FSI (IN SQM)
GROUND FLOOR		
FIRST FLOOR		
TOTAL AREA		
FSI		
PLOT COVERAGE (%)		

JOINERY SCHEDULE

TYPE	DESCRIPTION	SILL	LINTEL	SIZE
MD	MAIN DOOR	-	2400	1200 X 2400
KW	KITCHEN WINDOW	1050	2400	1500 X 1350

FOR SPECIAL NOTES

R.NO	DESCRIPTION	DATE
1	ENTRANCE GATE RELOCATED TO SOUTH EAST	23-05-2017
REVISIONS		

SIGN & SEAL

DRAWN BY : XXXX
 DRAWN BY : XXXX
 PROJECT : SHED
 LOCATION : XXXX
 DRAWING TITLE : Shed Floor Plan

DATE : XX.XX.XXXX
 SCALE : 1 : 1 A2 SHEET NO. : 01

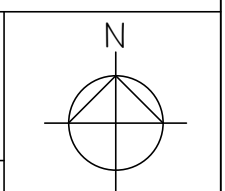

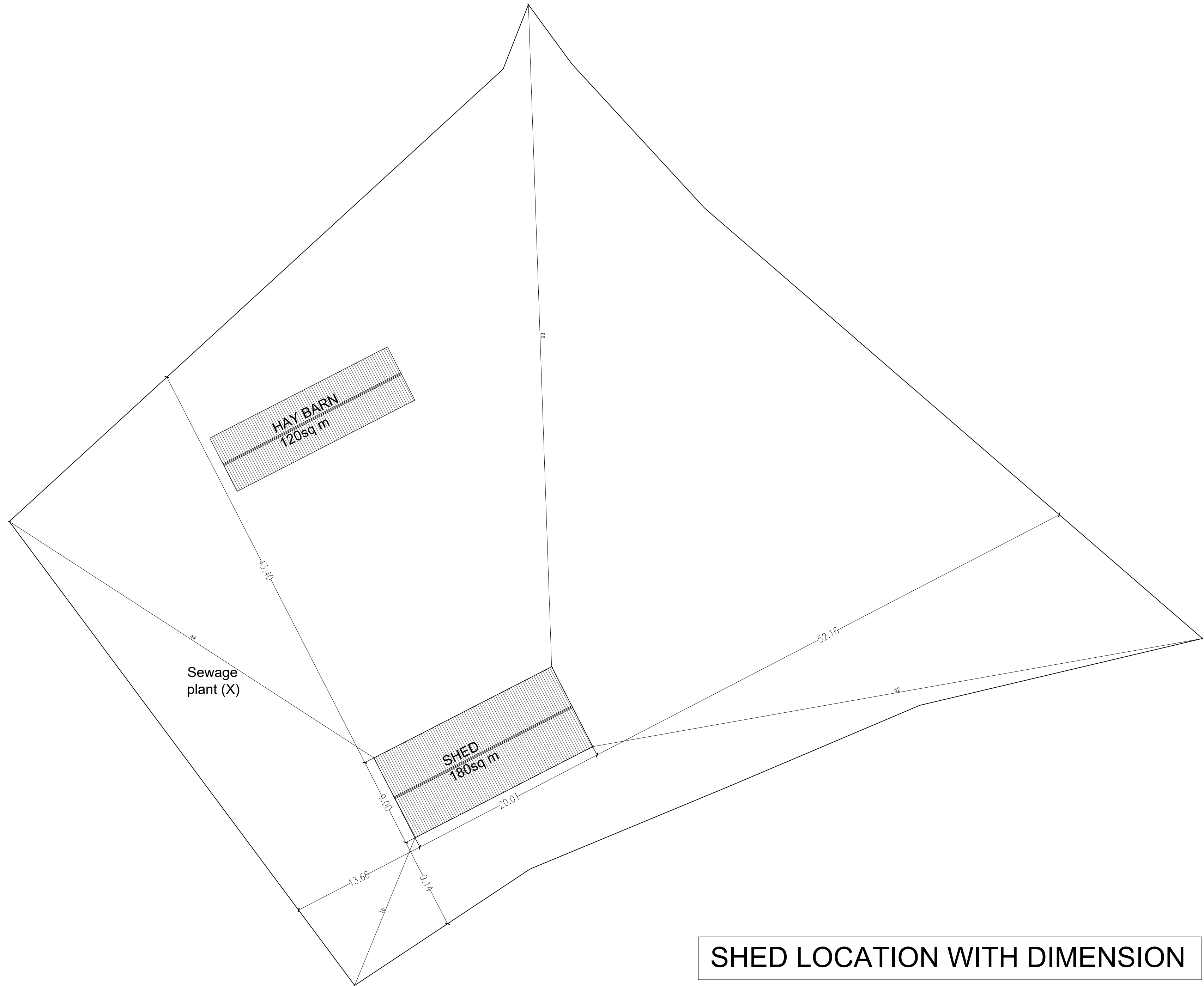

	RCC WORK
	BRICK WORK
	POROTHERM WALL
	SOLID CONCRETE BLOCK WORK
	AAC BLOCK WORK

AREA STATEMENT

SITE AREA	: XXXX.XXXX SQM	
DESCRIPTION	FSI AREA (IN SQM)	NON FSI (IN SQM)
GROUND FLOOR		
FIRST FLOOR		
TOTAL AREA		
FSI		
PLOT COVERAGE (%)		

JOINERY SCHEDULE

TYPE	DESCRIPTION	SILL	LINTEL	SIZE
MD	MAIN DOOR	-	2400	1200 X 2400
KW	KITCHEN WINDOW	1050	2400	1500 X 1350

FOR SPECIAL NOTES

1	ENTRANCE GATE RELOCATED TO SOUTH EAST	23-05-2017
R.NO	DESCRIPTION	DATE
1	REVISIONS	

SIGN & SEAL

DRAWN BY	: XXXX
DRAWN BY	: XXXX
PROJECT	: SHED
LOCATION	: XXXX

DRAWING TITLE : Shed Floor Plan

SIGN	
DATE : XX.XX.XXXX	
SCALE : 1 : 1 A2	SHEET NO. : 01

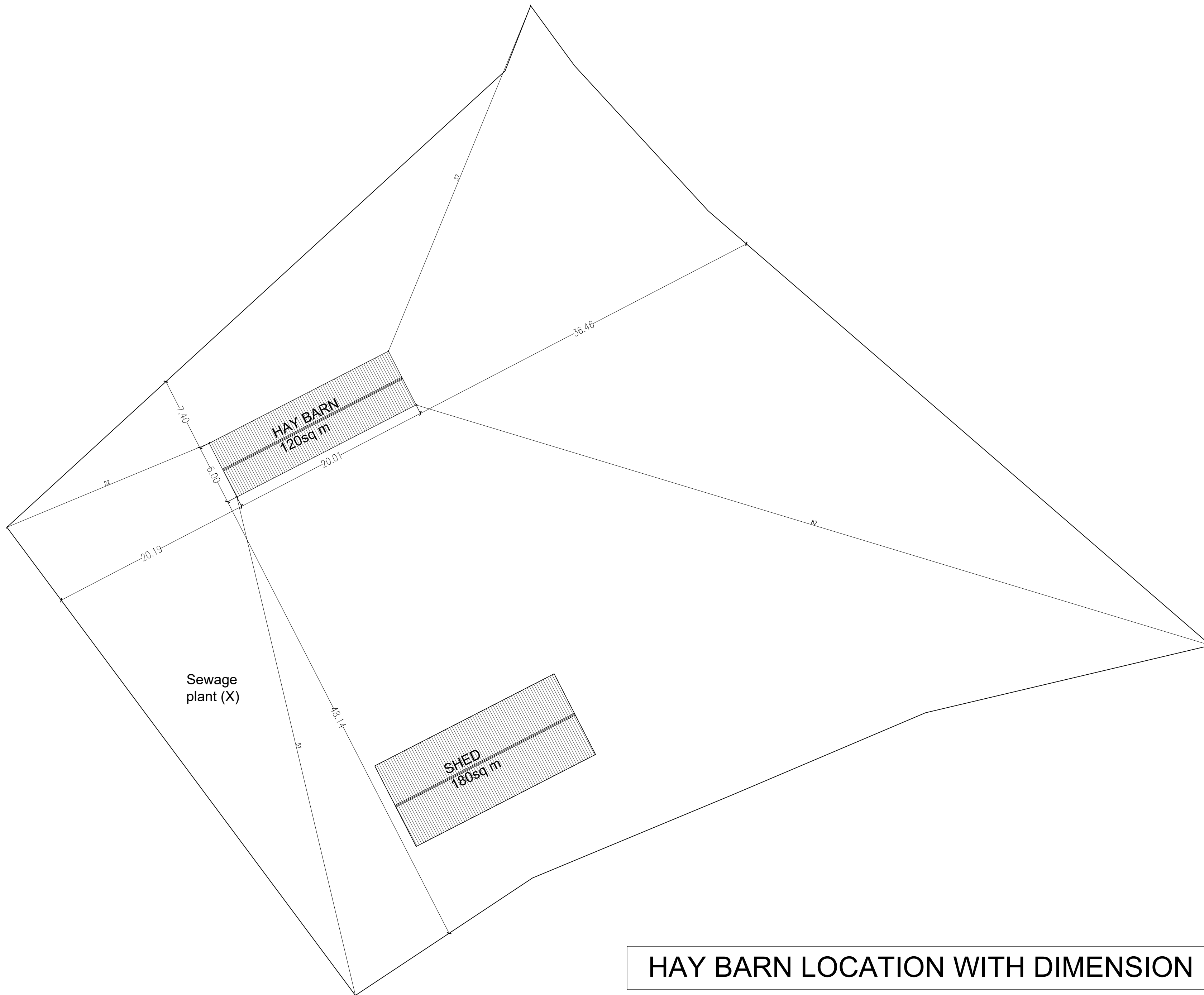

	RCC WORK
	BRICK WORK
	POROTHERM WALL
	SOLID CONCRETE BLOCK WORK
	AAC BLOCK WORK

AREA STATEMENT

SITE AREA	: XXXX.XXX SQM	
DESCRIPTION	FSI AREA (IN SQM)	NON FSI (IN SQM)
GROUND FLOOR		
FIRST FLOOR		
TOTAL AREA		
FSI		
PLOT COVERAGE (%)		

JOINERY SCHEDULE

TYPE	DESCRIPTION	SILL	LINTEL	SIZE
MD	MAIN DOOR	-	2400	1200 X 2400
KW	KITCHEN WINDOW	1050	2400	1500 X 1350

FOR SPECIAL NOTES

1	ENTRANCE GATE RELOCATED TO SOUTH EAST	23-05-2017
R.NO	DESCRIPTION	DATE
1	REVISIONS	

SIGN & SEAL

DRAWN BY	: XXXX
DRAWN BY	: XXXX
PROJECT	: SHED
LOCATION	: XXXX
DRAWING TITLE	Shed Floor Plan

SIGN	
DATE	: XX.XX.XXXX
SCALE	: 1 : 1 A2 SHEET NO. : 01

HAY BARN LOCATION WITH DIMENSION

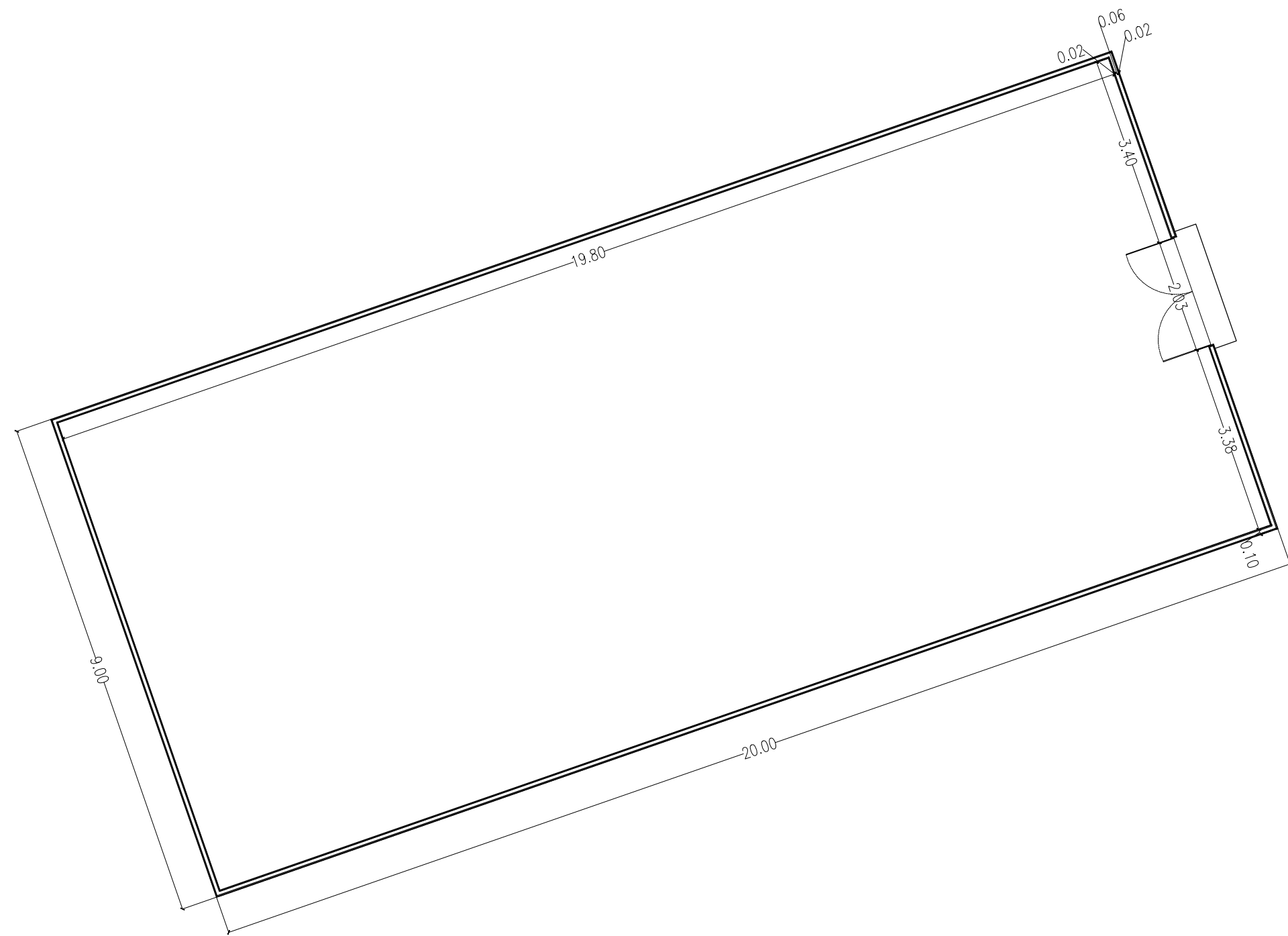
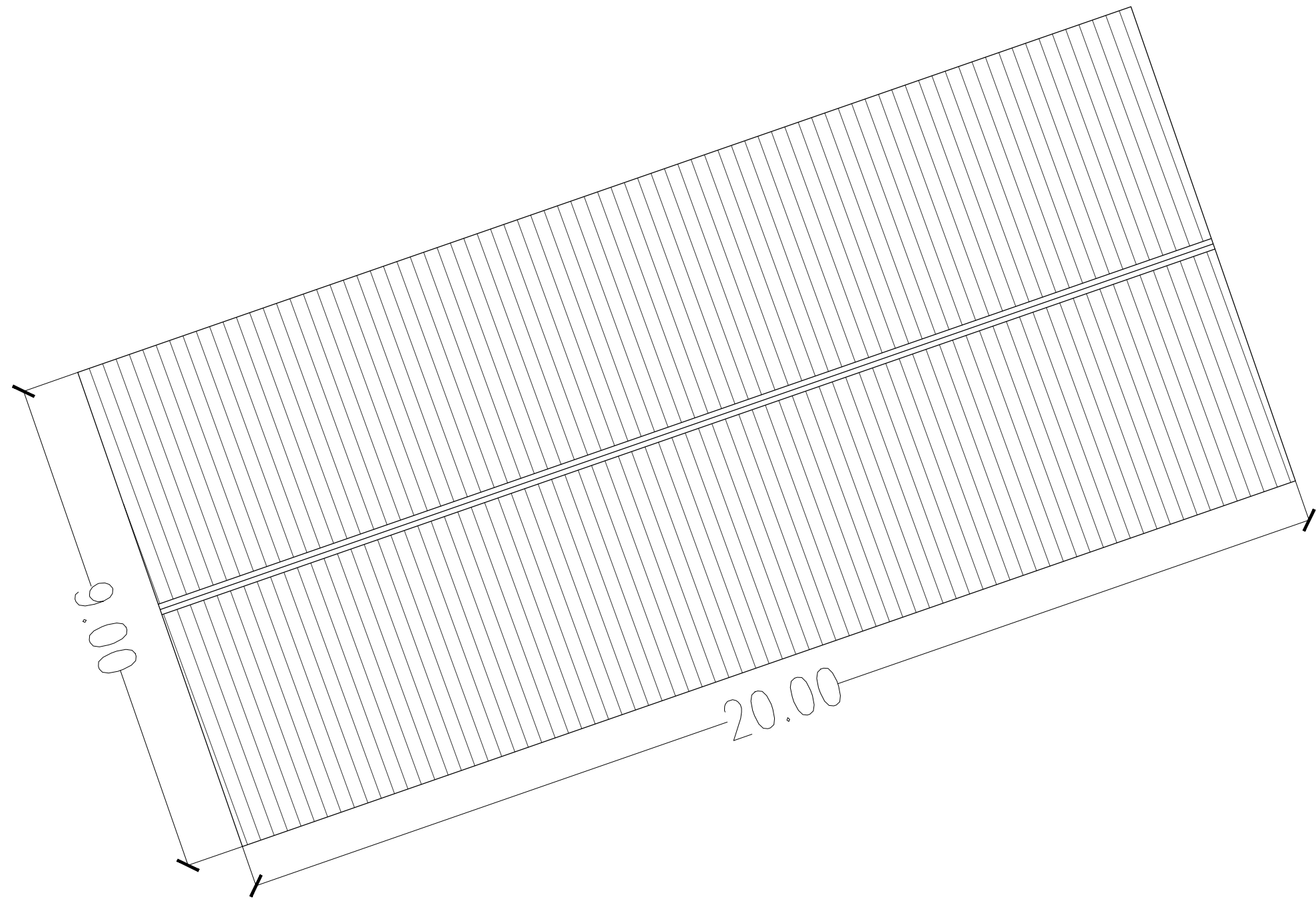

	RCC WORK
	BRICK WORK
	POROTHERM WALL
	SOLID CONCRETE BLOCK WORK
	AAC BLOCK WORK

AREA STATEMENT

SITE AREA : XXXX.XXXX SQM	
DESCRIPTION	FSI AREA (IN SQM) / NON FSI (IN SQM)
GROUND FLOOR	
FIRST FLOOR	
TOTAL AREA	
FSI	
PLOT COVERAGE (%)	

JOINERY SCHEDULE

TYPE	DESCRIPTION	SILL	LINTEL	SIZE
MD	MAIN DOOR	-	2400	1200 X 2400
KW	KITCHEN WINDOW	1050	2400	1500 X 1350

FOR SPECIAL NOTES

1	ENTRANCE GATE RELOCATED TO SOUTH EAST	23-05-2017
R.NO	DESCRIPTION	DATE
1	REVISIONS	

SIGN & SEAL

DRAWN BY : XXXX
 DRAWN BY : XXXX
 PROJECT : SHED
 LOCATION : XXXX

DRAWING TITLE : Shed Floor Plan

DRAWING TITLE : SIGN

DATE : XX.XX.XXXX

SCALE : 1 : 1 A2 SHEET NO. : 01

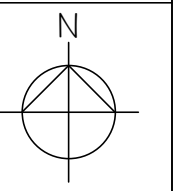

Shed drawings

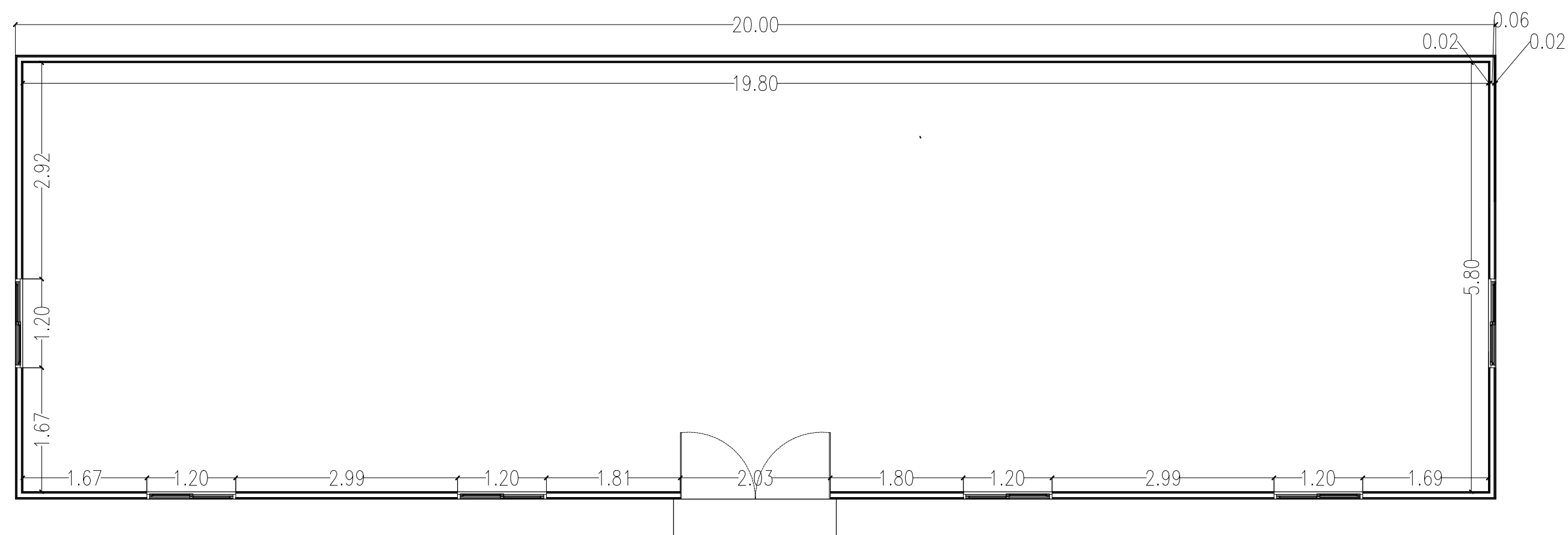
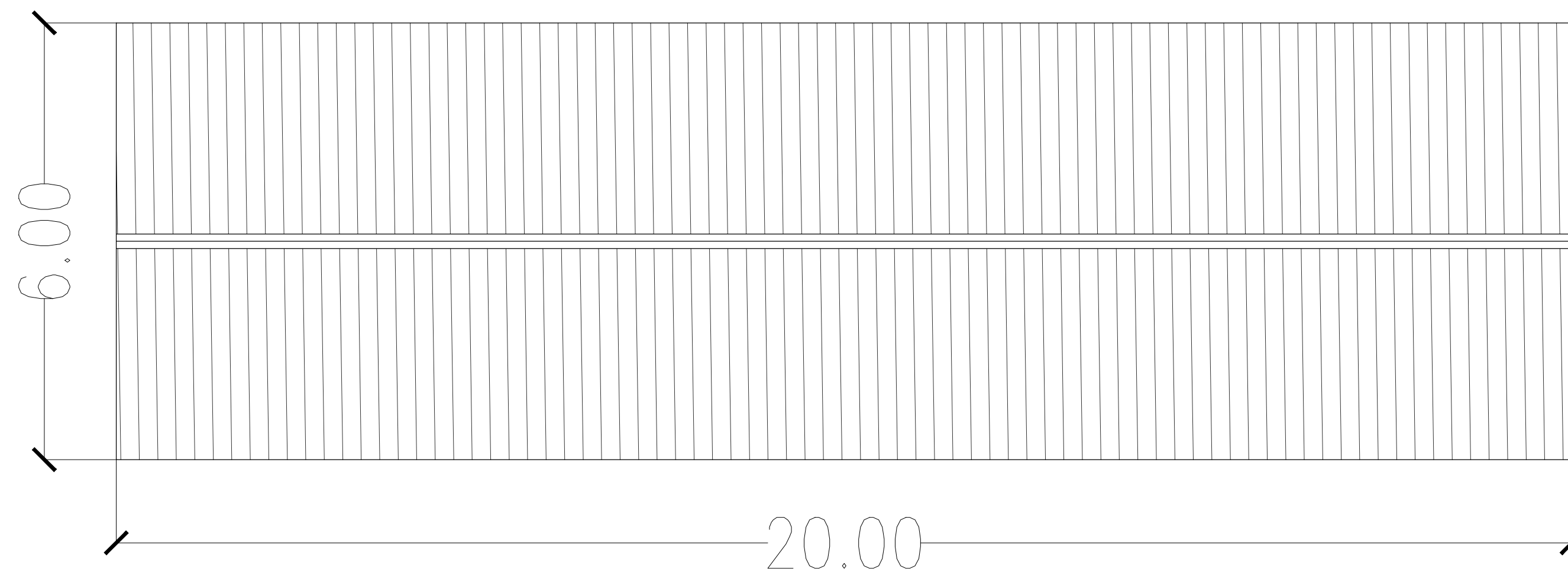

	RCC WORK
	BRICK WORK
	POROTHERM WALL
	SOLID CONCRETE BLOCK WORK
	AAC BLOCK WORK

AREA STATEMENT		
DESCRIPTION	FSI AREA (IN SQM)	NON FSI (IN SQM)
GROUND FLOOR		
FIRST FLOOR		
TOTAL AREA		
FSI		
PLOT COVERAGE (%)		

JOINERY SCHEDULE				
TYPE	DESCRIPTION	SILL	LINTEL	SIZE
MD	MAIN DOOR	-	2400	1200 X 2400
KW	KITCHEN WINDOW	1050	2400	1500 X 1350

FOR SPECIAL NOTES

R.NO	DESCRIPTION	DATE
1	ENTRANCE GATE RELOCATED TO SOUTH EAST	23-05-2017
1	REVISIONS	

SIGN & SEAL

DRAWN BY	: XXXX
PROJECT	: SHED
LOCATION	: XXXX
DRAWING TITLE	Shed Floor Plan

Hay Barn Plan

SIGN		
DATE		: XX.XX.XXXX
SCALE		: 1 : 1 A2 SHEET NO. : 01

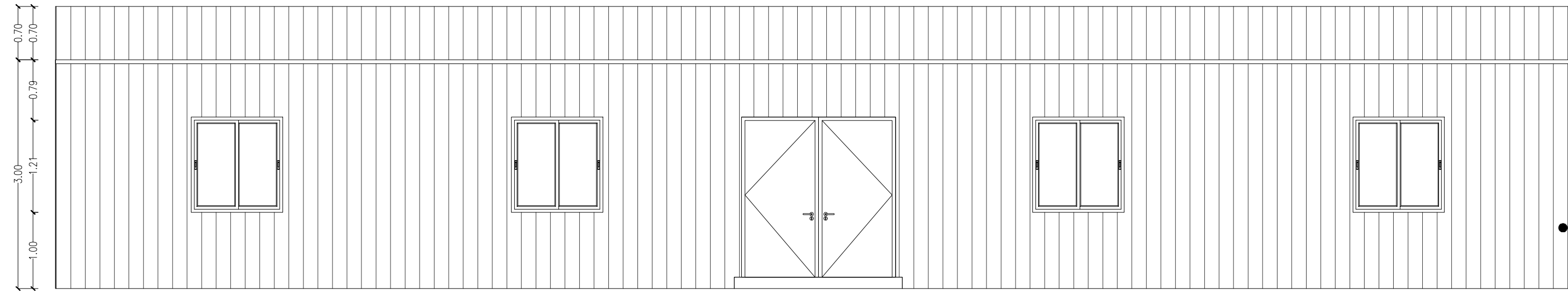

Steel sheet on concrete base

Front Elevations

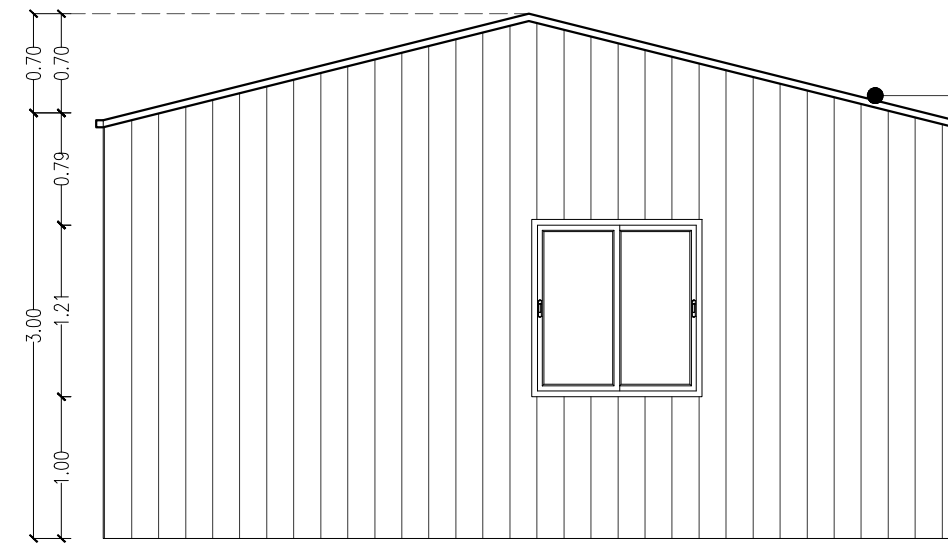

Sloped Steel sheet

Side Elevations

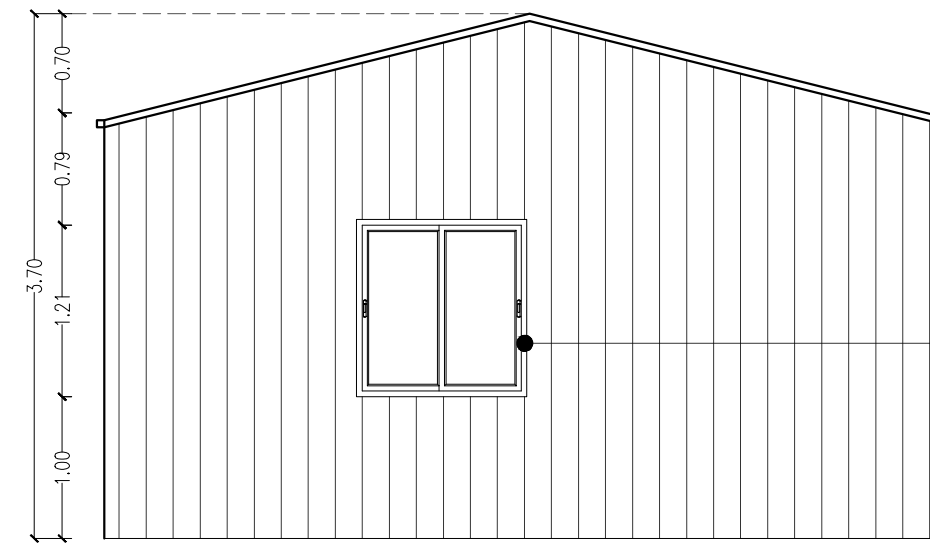

Window opening

Side Elevations

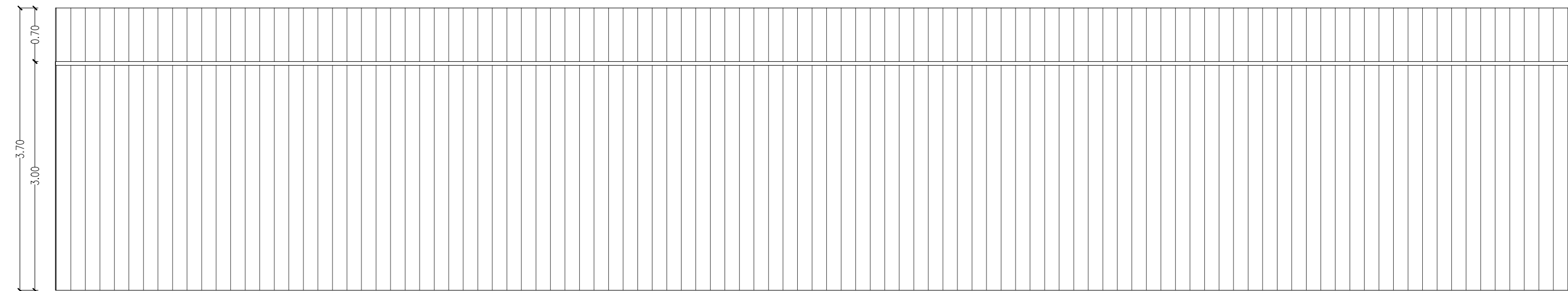

Rear Elevations

	RCC WORK
	BRICK WORK
	POROTHERM WALL
	SOLID CONCRETE BLOCK WORK
	AAC BLOCK WORK

AREA STATEMENT

SITE AREA		: XXXX.XXXX SQM	
DESCRIPTION	FSI AREA (IN SQM)	NON FSI (IN SQM)	
GROUND FLOOR			
FIRST FLOOR			
TOTAL AREA			
FSI			
PLOT COVERAGE (%)			

JOINERY SCHEDULE

TYPE	DESCRIPTION	SILL	LINTEL	SIZE
MD	MAIN DOOR	-	2400	1200 X 2400
KW	KITCHEN WINDOW	1050	2400	1500 X 1350

FOR SPECIAL NOTES

1	ENTRANCE GATE RELOCATED TO SOUTH EAST	23-05-2017
---	---------------------------------------	------------

R.NO	DESCRIPTION	DATE
1	REVISIONS	

SIGN & SEAL

DRAWN BY : XXXX
 DRAWN BY : XXXX
 PROJECT : SHED
 LOCATION : XXXX

DRAWING TITLE : Shed Floor Plan

SIGN

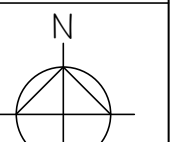

DATE : XX.XX.XXXX
 SCALE : 1 : 1 A2 SHEET NO. : 01

Hay Barn Elevations

Comhairle Contae Chorcaí Cork County Council

Pleanáil agus Forbairt,
Halla an Chontae,
Bóthar Charraig Ruacháin,
Corcaigh T12 R2NC.

Fón: (021) 4276891
R-phost: planninginfo@corkcoco.ie
Suíomh Gréasáin: www.corkcoco.ie
Planning & Development,

County Hall,
Carrigrohane Road, Cork T12 R2NC.

Tel (021) 4276891
Email: planninginfo@corkcoco.ie
Web: www.corkcoco.ie



David O'Keeffe,
Ballinvuskig West,
Mourneabbey,
Co. Cork.
P51 T6TO

11th October, 2024

Our Ref.: D/263/24

Re: Declaration of Exempted Development under Section 5 of The Planning and Development Act 2000 – 2010.

Whether the construction of a dry shed for the storage of hay to feed sheep in winter months at Ballinvuskig West, Mourneabbey, Co. Cork is or is not development and is or is not exempted development.

Dear Sir,

I refer to your application for a Declaration of Exemption in relation to the above.

It is considered that the information submitted with the Section 5 Declaration application is insufficient to enable the Planning Authority to make a determination in this case. You are therefore requested to submit the following further information :

1. Class 9 of Part 3, Schedule 2 of the Planning and Development Regulations provides for works consisting of the provision of any store, barn, shed, glass-house or other structure, not being a type specified in Class 6, 7 or 8 of Part 3 and having a gross floor space not exceeding 300sq.m subject to the limitations set out in Column 2 of Class 9. It is not clear from the information submitted whether the structure complies with all of the limitations set out in Column 2 of Class 9, Part 3, Schedule 2.

Please provide details of materials and finishes. As per Class 9 Conditions and Limitations. Please note no unpainted metal sheeting should be used for roofing or on the external finish of the structure.

Yours faithfully,

ANGELA CARRIGY
ASO PLANNING DEPARTMENT.

In order to process your query, it may be necessary for Cork County Council to collect Personal information from you. Such information will be processed in line with our privacy statement which is available to view at <https://www.corkcoco.ie/privacy-statement-cork-county-council>



We are Cork.



Recycled

SECTION 5 DECLARATION – PLANNER’S REPORT

File Reference: D/263/24
Description: Dry shed for the storage of hay to feed sheep in the winter months.
Applicant: David O’Keeffe
Location: Ballinvustig West, Moourneabbey, Co. Cork
Date: 10/10/2024

SUMMARY OF RECOMMENDATION

Further Information Request

PURPOSE OF REPORT

Under Section 5 of the Planning and Development Act, 2000 (as amended), if any question arises as to what, in any particular case, is or is not development and is or is not exempted development within the meaning of the Act, any person may, on payment of the prescribed fee, request in writing from the relevant planning authority a declaration on that question, and that person shall provide to the planning authority any information necessary to enable the authority to make its decision on the matter.

SITE LOCATION

The subject lands at Ballinvuskig West, Mallow adjoins with and extends Westwards from the minor County road, the L1221, and lies c. 770 m to the north of Ballinvustig Cross Roads and c. 860 m to the south of Knoppoge Bridge. This site is also sited circa 2.5 km to the East of the N20 Cork to Mallow road.

SUBJECT DEVELOPMENT

Whether the contrition of a dry shed for the storage of hay is or is not development and is or is not exempted development.

PLANNING HISTORY

Planning Ref.	Development Description	Decision
D/239/24	Construction of a shed for housing of sheep.	Is Development and Is Exempted Development.

LEGISLATIVE CONTEXT

Planning & Development Act, 2000 (as amended)

Section 2(1) of the Act states the following in respect of ‘works’: “Any act or operation of construction, excavation, demolition, extension, alteration, repair or renewal...”

Section 3(1) of the Act states the following in respect of ‘development’: “In this Act, ‘development’ means, except where the context otherwise requires, the carrying out of any works on, in, over or under land or the making of any material change in the use of any structures or other land.”

Section 4(1) sets out various forms and circumstances in which development is exempted development for the purposes of the Act. Section 4 (1) (a) states that development consisting of the use of any land for the purposes of agriculture and development consisting of the use for that purpose of any building occupied together with land so used.

Section 4 (2)(a) of the Act enables certain classes of development to be deemed exempted development by way of regulation.

Section 4(4) states that notwithstanding paragraph (a) of subsection (1) and any regulations under subsection (2), development shall not be exempted development if an environmental impact assessment or an appropriate assessment is required.

Planning & Development Regulations 2001 (as amended)

Article 6(3) states: Subject to Article 9, in areas other than a city, a town or an area specified in section 19 (1) (b) of the Act or the excluded areas as defined in section 9 of the Local Government (Reorganisation) Act, 1985 (No.7 of 1985), development of a class specified in Column 1 of Part 3 of Schedule 2 shall be exempted development for the purposes of the Act, provided that such development complies with the conditions and limitations specified in column 2 of the said Part 3 opposite the mention of that class in the said column 1.

Restrictions on exemption by virtue of Article 9(1)(a) of the Planning and Development Regulations 2001 (as amended)

Article 9 (1) (a) provides that certain development to which Article 6 relates (i.e. exempted development) shall not be exempted in various circumstances. Article 9(1) states that: Development to which Article 6 relates shall not be exempted development for the purposes of the Act – (a) if the carrying out of such development would:

- (ii) consist of or comprise the formation, laying out or material widening of a means of access to a public road the surfaced carriageway of which exceeds 4m in width
- (iii) endanger public safety by reason of traffic hazard or obstruction of road users,
- (viii) consist of or comprise the extension, alteration, repair or renewal of an unauthorised structure or a structure the use of which is an unauthorised use,
- (viiB) comprise development in relation to which a planning authority or An Bord Pleanála is the competent authority in relation to appropriate assessment and the development would require an appropriate assessment because it would be likely to have a significant effect on the integrity of a European site.

Schedule 2, Part 3 Exempted Development – Rural

Column 1 Description of Development	Column 2 Conditions and Limitations
<i>Agricultural Structures</i>	

<p>CLASS 9</p> <p>Works consisting of the provision of any store, barn, shed, glass-house or other structure, not being of a type specified in class 6, 7 or 8 of this Part of this Schedule, and having a gross floor space not exceeding 300sqm.</p>	<ol style="list-style-type: none"> 1. No such structure shall be used for any purpose other than the purpose of agriculture or forestry, but excluding the housing of animals or the storing of effluent. 2. The gross floor space of such structures together with any other such structures situated within the same farmyard complex or complex of such structures or within 100m of that complex shall not exceed 900sqm gross floor space in aggregate. 3. No such structure shall be situated within 10m of any public road. 4. No such structure within 100m of any public road shall exceed 8m in height. 5. No such structure shall be situated within 100m of any house (other than the house of the person providing the structure) or other residential building or school, hospital, church or building used for public assembly, save with the consent in writing of the owner and, as may be appropriate, the occupier or person in charge thereof. 6. No unpainted metal sheeting shall be used for roofing or on the external finish of the structure.
---	---

SUB-THRESHOLD EIAR

Having regard to the contents of Article 103 (as amended by Article 14 of the Planning and Development (Amendment) (No3) Regulations 2011) and Schedule 7 of the Planning and Development Regulations 2001 (as amended) it is considered that the proposed development by reason of its nature, scale and location would not be likely to have significant effects on the environment. Accordingly it is considered that an EIS is not required to be submitted.

APPROPRIATE ASSESSMENT

Having regard to its nature, scale and location it is considered that the proposed development would not affect the integrity of Natura 2000 sites. Accordingly it is considered that a Natura Impact Statement for the purposes of Article 6 of the Habitats Directive is not required to be submitted.

ASSESSMENT

The question before the Planning Authority can be reasonably construed as:

Whether the construction of a dry shed for the storage of hay at Ballinvustig West, Mourneabbey, Co. Cork is development and is or is not exempted development.

The application is accompanied by a site location map, layout plan and plans and elevations of the structure in question.

Is or is not development?

Development is defined, under Section 3(1) of the Planning and Development Act, 2000 (as amended), as “the carrying out of works on, in, over or under land...” Works are defined, under Section 2(1) of this Act, as including “any act or operation of construction, excavation, demolition, extension.

The construction of the proposed dry shed for storage of hay consists of the carrying out of ‘works’ and therefore constitutes ‘development’, as defined in Section 3 of the Planning and Development Act 2000, as amended.

Is or is not exempted development?

Part 3 of Schedule 2 provides for Agricultural Structures and Class 9 refers to:

Works consisting of the provision of any store, barn, shed, glass-house or other structure, not being of a type specified in class 6, 7 or 8 of this Part of this Schedule, and having a gross floor space not exceeding 300sqm.

- It is stated by the applicant that the proposed structure will be used for the storage of hay for feeding sheep (note recent Section 5 ref. D/239/24 in respect of sheep shed 180sqm). Therefore the structure is not a type specified in Class 6, 7 or 8 of Part 3, Schedule 2;
- The gross floor space of the subject structure is stated as 120sqm. The gross floor space including the sheep shed (ref. D/239/24) is 300sqm;
- The structure is for agricultural use, for storage of hay only, and not for housing of animals or storing of effluent;
- The proposed development is located over 100m from the nearest farm complex;
- The structure is situated over 100m from the public road;
- The structure is situated more than 100 from the public road as it is accessed from a private lane and does not exceed 8m in height. The structure measures approximately 3.7m in height;
- The nearest dwelling, which is the applicant’s dwelling is situated over 120m from the proposed structure.
- No unpainted metal sheeting shall be used for roofing or on the external finish of the structure. The drawings indicate steel sheeting but the applicant has not confirmed whether it will be painted. Further details are required to confirm compliance with the conditions and limitations of Class 9.

The applicant has outlined their landholding. There are no other structures within the landholding. The nearest farm complex is outside of the applicant's ownership.

RECOMMENDATION

There is insufficient information on the file at present to enable the Planning Authority to assess the application in full. Accordingly, it is recommended that the following **FURTHER INFORMATION** is requested:

1. Class 9 of Part 3, Schedule 2 of the Planning and Development Regulations provides for works consisting of the provision of any store, barn, shed, glass-house or other structure, not being of a type specified in Class 6, 7 or 8 of Part 3 and having a gross floor space not exceeding 300sqm subject to the limitations set out in column 2 of Class 9. It is not clear from the information submitted whether the structure complies with all of the limitations set out in Column 2 of Class 9, Part 3, Schedule 2. The applicant is therefore requested to clarify the following:
 - a. Please provide details of materials and finishes. As per Class 9 conditions and limitations. Please note no unpainted metal sheeting should be used for roofing or on the external finish of the structure.



Louise Ahern
A/Senior Executive Planner
10/10/2024

ENGINEERS REPORT D/263/24

Having looked at this Section 5, the following are my views from a roads viewpoint.

The proposed shed would be served from an existing passageway that serves the house. Planning was granted in 10/5356 for a house and extended under 15/5806 and retained under 18/5517.

I have no objection to the proposed dry shed for the storage of hay from a roads viewpoint.

Kind Regards

Andreana

Andreana Sheehan | Innealtóir Feidhmiúcháin | Roinn na mBóithre
Comhairle Contae Chorcaí | Annabella | Mala | P51 Y6YT | Éire
Tirseach na gcustaiméirí : www.yourcouncil.ie



CORK COUNTY COUNCIL APPLICATION FOR SECTION 5 DECLARATION OF EXEMPTION

APPLICANT CHECKLIST

(Please tick ✓)

- ~~4 No. Copies of Application Form:~~ ✓
- ~~1 No. Copy of Contact Details:~~ ✓
- ~~4 No. Copies 6" O.S. Maps:~~ ✓
- ~~4 No. Copies 25" O.S. Maps:~~ ✓
- ~~4 No. Copies of Site Layout Plan:~~ X
- ~~4 No. Copies Scaled Drawings of Development:~~ X
- ~~€80 Application Fee:~~ ✓



FOR OFFICE USE ONLY

Receipt No.	PL60045843
Cash/Cheque/ Credit Card	CARD
Date	16/9/24
Declaration Ref. No.	D/263/24

DATE STAMP HERE

You should make sure that you are satisfied that any information/documentation that you submit is appropriate to be viewed by the public. Please do not submit any information that you do not want 3rd parties to view.

In the case of a Declaration of Exemption for Land Reclamation, the following additional information is required:

- A copy of the details submitted to the Council's Environment Department (Inniscarra) for a Waste Licence Permit
- Correspondence from Teagasc (detailing how the land reclamation would benefit the land in question for agricultural purposes)
- Details of existing and proposed levels
- Details of fill material and duration of fill.

DATA PROTECTION

The planning process is an open and public one. In that context, all applications for Declarations of Exemption are made available for public inspection.

Personal information collected by Cork County Council is done so in order for us to process your application for a Section 5 Declaration of Exemption. Legally we can process this information as it is necessary for us to comply with our statutory/legal obligations. The protection of our personal data is a key priority for the Council and your data will be processed in line with our Privacy policy which is available at <http://www.corkcoco.ie/Privacy-Policy> or hardcopy from our offices at County Hall, Carrigrohane Road, Cork, Ireland. Should you have any questions about our privacy policy or the information we hold about you, please contact us by email to dpo@corkcoco.ie or write to us at Data Protection Officer, Cork County Council, County Hall, Carrigrohane Road, Cork, Ireland.

1. NAME OF APPLICANT: (ADDRESS TO BE SUPPLIED AT QUESTION A - CONTACT DETAILS)

David O Keefe

2. POSTAL ADDRESS OF LAND OR STRUCTURE FOR WHICH DECLARATION OF EXEMPTION IS SOUGHT:

Ballinurragh west mownabbey co. cork
PSIT6TO

Planning Department
16 SEP 2024
Cork County Council
County Hall
Cork.

~~027485860~~

3. QUESTION/DECLARATION DETAILS:

Please state the specific question for which a Declaration of Exemption is sought

Note: Only works listed and described under this section will be assessed under the Section 5 Declaration of Exemption

I'll need a dry shed for the storage of hay to feed my sheep in the winter months. I've recently got a exemption D/239/24 for sheep housing and a hay barn, would complete the needs for keeping sheep with the department of agriculture, and I'd be able to live away on the farm having a sheep enterprise set up. All works will comply with the department of agriculture and I'm a young farmer with the DAFM, herd number D3481540. I'm the owner of the farm where proposed hay barn is to be built.

4. APPLICATION DETAILS:

Answer the following if applicable. Note: Floor areas are measured from the inside of the external walls and should be indicated in square metres (m²)

(a) Floor area of existing/proposed structure(s):	
(b) If a domestic extension is proposed, have any previous extensions/structures been erected at this location after 1 st October, 1964 (including those for which planning permission has been obtained):	Yes <input type="checkbox"/> No <input checked="" type="checkbox"/> If yes, please provide floor areas (m ²) and previous planning reference(s) where applicable:
(c) If a change of use of land and/or building(s) is proposed, please state the following: Existing/previous use _____ Proposed use _____	
(d) Are you aware of any enforcement proceedings connected to this site?	Yes <input type="checkbox"/> No <input checked="" type="checkbox"/> If yes, please state relevant reference number(s):

5. LEGAL INTEREST OF APPLICANT IN THE LAND/STRUCTURE:

Please tick appropriate box to show applicant's legal interest in the land or structure:	A. Owner <input checked="" type="checkbox"/>	B. Other <input type="checkbox"/>
Where legal interest is "Other", please state your interest in the land/structure:		Planning Department
If you are not the legal owner, please state the name of the owner/s (address to be supplied at Question C in Contact Details):		16 SEP 2024 Cork County Council County Hall Cork

6. PROTECTED STRUCTURE DETAILS / ARCHITECTURAL CONSERVATION AREA:

Is this a Protected Structure/Proposed Protected Structure or within the curtilage of a Protected Structure: Yes <input type="checkbox"/> No <input checked="" type="checkbox"/>
If yes, has a Declaration under Section 57 of the Planning & Development Act 2000 been requested or issued for the property by the Planning Authority: Yes <input type="checkbox"/> No <input type="checkbox"/>
If yes, please state relevant reference No. _____
Is this site located within an Architectural Conservation Area (ACA), as designated in the County Development Plan? Yes <input type="checkbox"/> No <input checked="" type="checkbox"/>

7. APPROPRIATE ASSESSMENT:

Would the proposed development require an appropriate assessment because it would be likely to have a significant effect on the integrity of a European site (SAC, SPA etc)? Yes No

8. DATA PROTECTION DECLARATION:

In order for the Planning Authority to process the personal data you have provided, your consent is required. By ticking the box below, you consent to the Planning Authority processing the personal data provided by you in line with the terms of Cork County Council’s Privacy Policy available at <http://www.corkcoco.ie/privacy-statement-cork-county-council> or in hardcopy from any Council office; and to having your information processed for the following purposes:

Processing of your Declaration of Exemption application by the Planning Authority

I give permission for my personal information to be processed for the purpose stated above

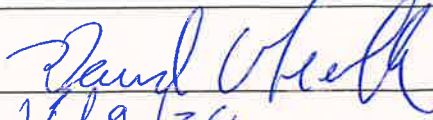
Signed (By Applicant Only)	
Date	16/9/24

GDPR Special Categories of data / Sensitive Personal data - Explicit Consent

Where Special Categories of personal data / sensitive personal data are provided as part of / in support of a declaration application, **explicit consent** to the processing of the special categories of data must be given by the person to whom the data refers, namely the Data Subject.

Special Categories of data / Sensitive Personal data include:

- Race
- Ethnic origin
- Political opinions
- Religion
- Philosophical beliefs
- Trade union membership
- Genetic data
- Biometric data
- Health data
- Concerning a natural person's sex life
- Sexual orientation

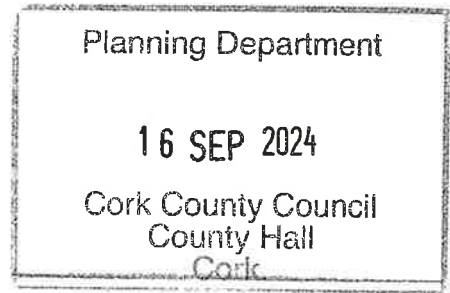

In order for the Planning Authority to process the sensitive personal data you have provided, your consent is required. By ticking the box below, you consent to the Planning Authority processing the personal data provided by you in line with the terms of Cork County Council’s Privacy Policy available at <https://www.corkcoco.ie/privacy-statement-cork-county-council> or in hardcopy from any Council office; and to having your information processed for the following purposes:

Sensitive personal data being submitted in support of Declaration of Exemption Application

I give permission for my sensitive personal data submitted to the Planning Authority to be processed for the purpose stated above.

Signed	
Date	16/9/24

You have the right to withdraw your consent by contacting the Planning Department, Ground Floor, County Hall, Carrigrohane Road, Cork. Tel: (021) 4276891 Email: planninginfo@corkcoco.ie or by contacting the Planning Department, Norton House, Cork Road, Skibbereen, Co. Cork. Tel: (028) 40340 Email: westcorkplanninginfo@corkcoco.ie However if consent to the use of personal data is withdrawn during the declaration of exemption decision-making process this information cannot be considered as part of the decision making process. Once a decision has been made, an applicant is not entitled to withdraw consent, as the right of erasure does not apply to a situation where processing is required for compliance with a legal obligation or for the performance of a task carried out in the public interest.

Please note that all information / supporting documentation submitted will be available publicly to view at the Planning Authority offices.

ADVISORY NOTES:

The application must be accompanied by the required fee of €80
 The application must be accompanied by a site location map which is based on the Ordnance Survey map for the area, is a scale not less than 1:1000 and it shall clearly identify the site in question.
 Sufficient information should be submitted to enable the Planning Authority to make a decision. If applicable, any plans submitted should be to scale and based on an accurate survey of the lands/structure in question.
 The application should be sent to the following address:
 The Planning Department, Cork County Council, Floor 2, Co. Hall, Carrigrohane Road, Cork, T12 R2NC; or for applications related to the Western Division, The Planning Department, Cork County Council, Norton House, Cork Road, Skibbereen, Co. Cork, P81 AT28.

- The Planning Authority may require further information to be submitted to enable the authority to issue a decision on the Declaration of Exemption application.
- The Planning Authority may request other person(s), other than the applicant; to submit information on the question which has arisen and on which the Declaration of Exemption is sought.
- Any person issued with a Declaration of Exemption may on payment to An Bord Pleanála refer a Declaration of Exemption for review by the Board within 4 weeks of the date of the issuing of the Declaration of Exemption decision.
- In the event that no Declaration of Exemption is issued by the Planning Authority, any person who made a request may on payment to the Board of such a fee as may be prescribed, refer the question for decision to the Board within 4 weeks of the date that a Declaration of Exemption was due to be issued by the Planning Authority.

The application form and advisory notes are non-statutory documents prepared by Cork County Council for the purpose of advising the type of information which is normally required to enable the Planning Authority to issue a Declaration of Exemption under Section 5. This document does not purport to be a legal interpretation of the statutory legislation nor does it state to be a legal requirement under the Planning and Development Act 2000 as amended, or Planning and Development Regulations, 2001, as amended.

9. I hereby declare that, to the best of my knowledge and belief, the information given in this form is correct, accurate and fully compliant with the Planning and Development Acts 2000, as amended and the Regulations made thereunder:

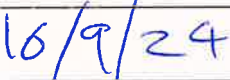
Signed (Applicant or Agent as appropriate)	
Date	

Planning Department

16 SEP 2024

Cork County Council
 County Hall
 Cork



**An Roinn Talmhaíochta,
Bia agus Mara**
Department of Agriculture,
Food and the Marine

For Basic Payment Income Support for Sustainability
Scheme, Areas of Natural Constraint Scheme and other
Area Based Scheme purposes only

Year: 2024 Scale: 1:4000

Name: DAVID O'KEEFFE
Address: FARMHOUSE
BALLINVUSKIG WEST
MALLOW
CO CORK
P51 T6T0

Townland Code : D34802
Townland Name: BALLINVUSKIG WEST

Parcel D3480200033 Digitised 17.44 Eligible Hectare 17.4 Claimed 17.4

Exclusions
Parcel D3480200033 Excl 0362 Area 0.04 Red% 100 Elig 0 Type Form Read

Ortho Used: VSCR_LATEST_ORTHO

All areas displayed above are in hectares

©Digital Globe/MAXAR Technologies

Imagery Dates: 28/03/2022
Unauthorized reproduction is not permitted.



D3481540

Page 1 of 2 Thu Jul 25 14:41:12 2024

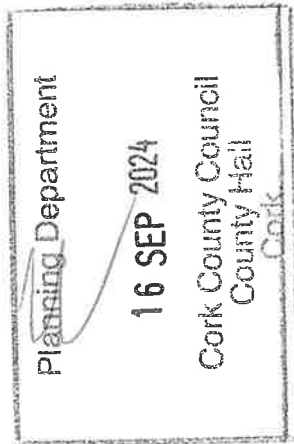

Farm

home
not my property

Site Location Map



Tailte Éireann

CENTRE COORDINATES:
ITM 658471,695278

PUBLISHED:
21/05/2024

ORDER NO.:
60401758_1

MAP SERIES:
6 Inch Raster
6 Inch Raster

MAP SHEETS:
CK033
CK042

COMPILED AND PUBLISHED BY:
Tailte Éireann,
Phoenix Park,
Dublin 8,
Ireland
D08F8E4

www.tailte.ie

Any unauthorised reproduction
infringes Tailte Éireann copyright.

No part of this publication may
be copied, reproduced or transmitted
in any form or by any means without
the prior written permission of the
copyright owner.

The representation on this map
of a road, track or footpath
is not evidence of the existence
of a right of way.

This topographic map
does not show
legal property boundaries,
nor does it show
ownership of physical features.

©Tailte Éireann, 2024.
All rights reserved.

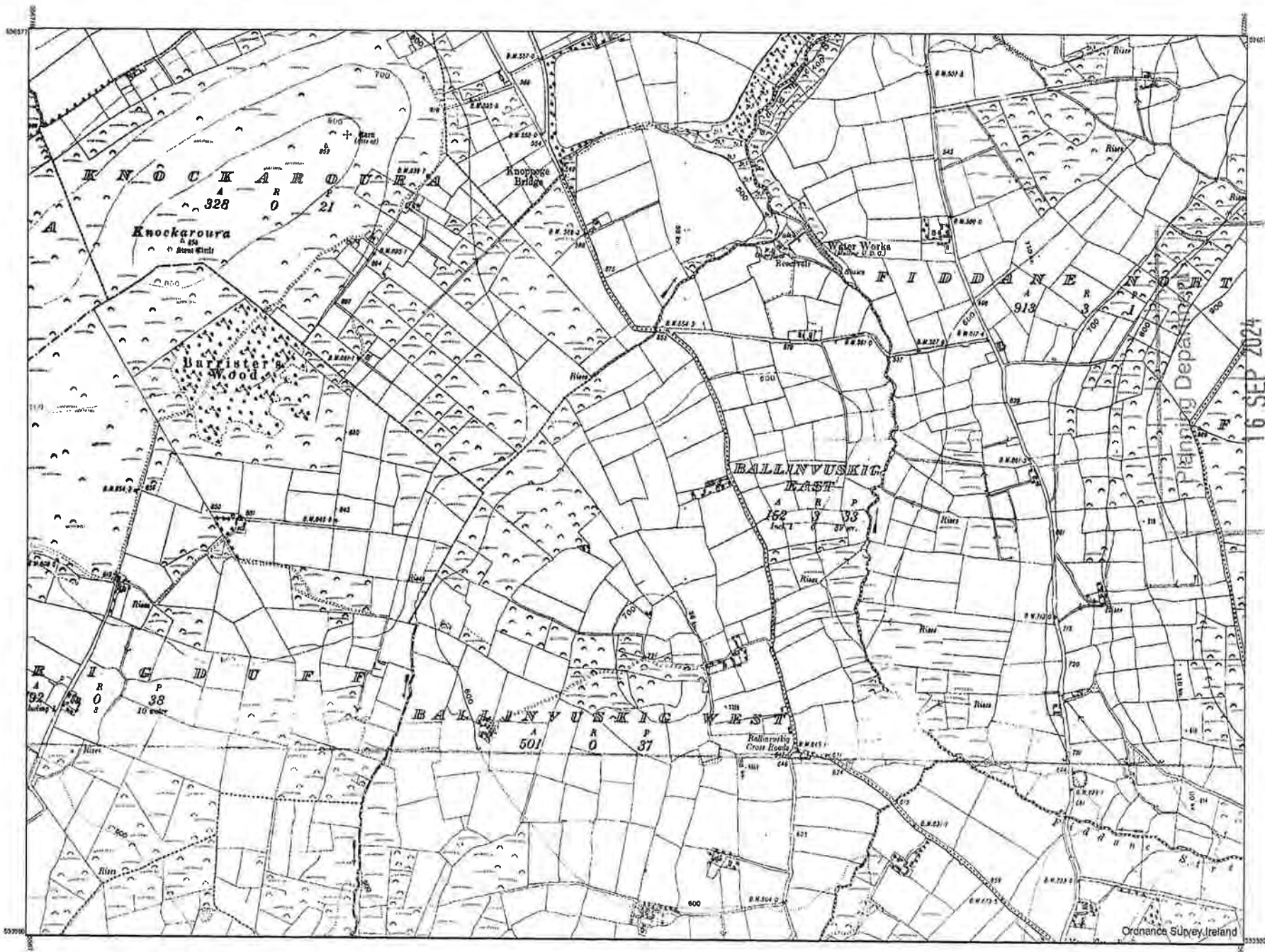

16 SEP 2024

County Council
County Hall
County Cork

Planning Department

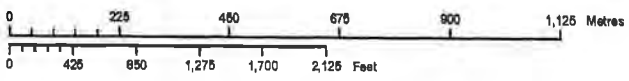

OUTPUT SCALE: 1:10,560

CAPTURE RESOLUTION:
The map objects are only accurate to the
resolution at which they were captured
Output scale is not indicative of data capture scale
Further information is available at:
www.tailte.ie; search 'Capture Resolution'

LEGEND:
To view the legend visit
www.tailte.ie and search for
'Large Scale Legend'



Ordnance Survey Ireland

Planning Department
 16 SEP 2024
 Cork County Council
 County Hall
 Cork

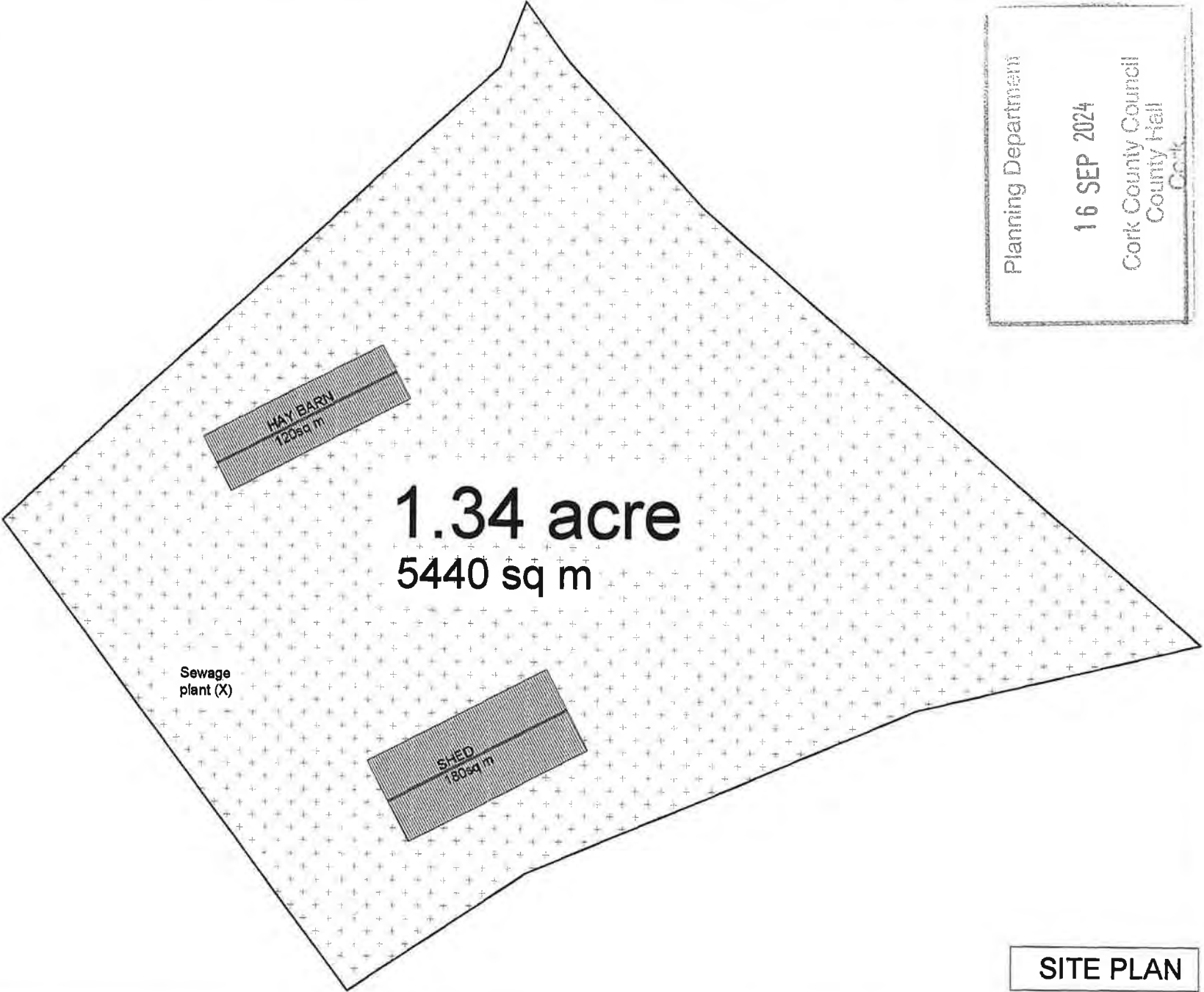

	RCC WORK
	BRICK WORK
	POROTHERM WALL
	SOLID CONCRETE BLOCK WORK
	AAC BLOCK WORK

AREA STATEMENT

SITE AREA	XXXX XXX SQM		
DESCRIPTION	FSI AREA	NO. OF	NO. OF
	(%)	(NO.)	(NO.)
GROUND FLOOR			
FIRST FLOOR			
TOTAL AREA			
FSI			
FLOOR COVERAGE (%)			

JOINERY SCHEDULE

TYPE	DESCRIPTION	SILL	LINTEL	SIZE
NO.	MAIN DOOR	2400	2400	1200 X 2400
NO.	KITCHEN WINDOW	1200	2400	1200 X 1200

FOR SPECIAL NOTES

ENTRANCE DATE RELOCATED TO SOUTH EAST	25/02/2017	
R NO.	DESCRIPTION	DATE
1	REVISIONS	

SIGN & SEAL

DRAWN BY : XXXX

DRAWN BY : XXXX

PROJECT : SHED

LOCATION : XXXX

DRAWING TITLE : Shed Floor Plan

DATE : XXXX XXXX

SCALE : 1:1 A2 SHEET NO : 01

SITE PLAN



Planning Pack Map



Tailte Éireann

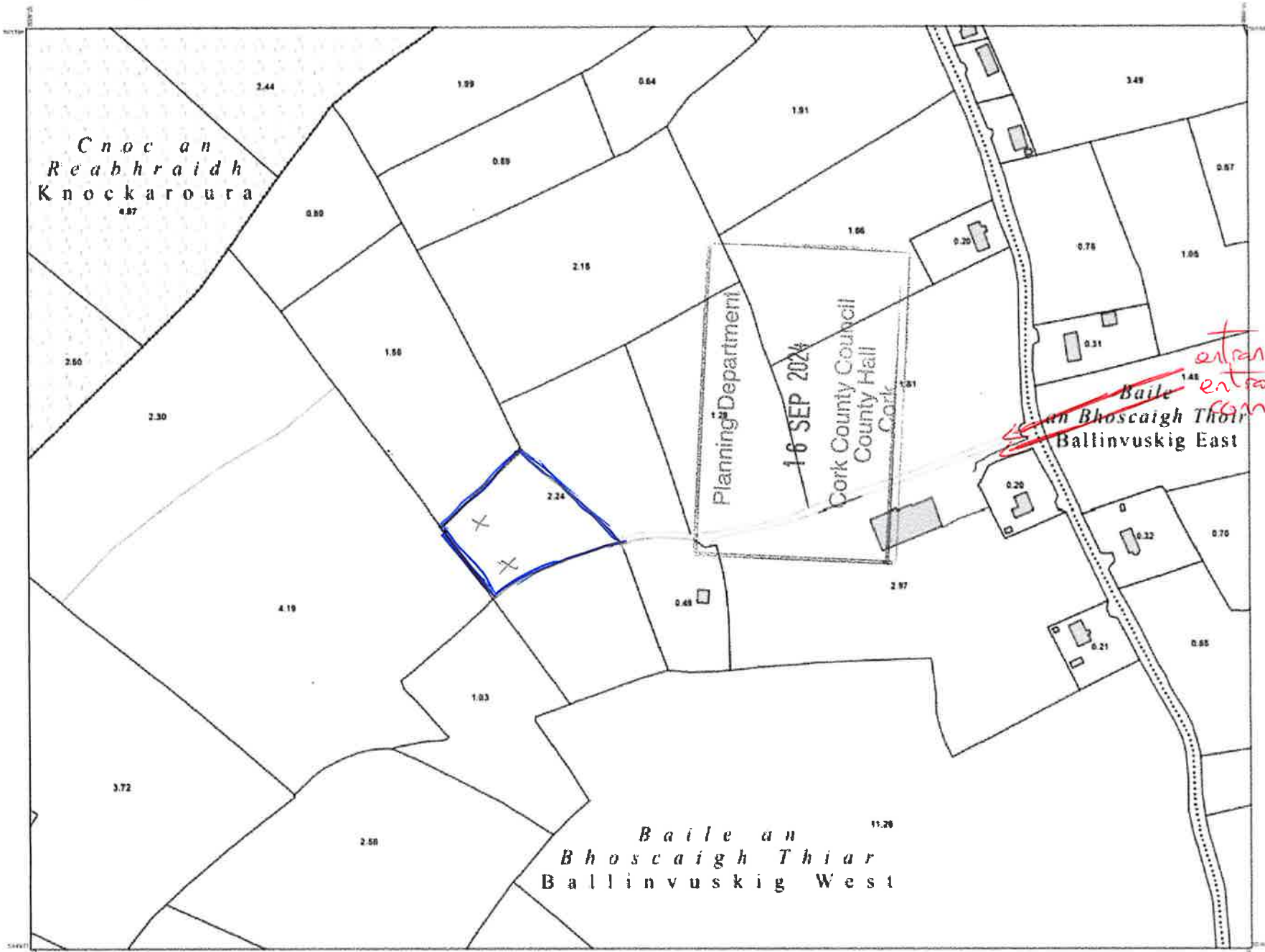

CENTRE COORDINATES:
11M 558471 695279

PUBLISHED:
21.09.2024

ORDER NO.
50431798_1

MAP SERIES:
1:2,500
1:2,500

MAP SHEETS:
8009-B
8009-C

COMPILED AND PUBLISHED BY:
Tailte Éireann
Proactive Plans,
Ducalis 8,
ireland
DOB# 614

www.tailte.ie

Any unauthorised reproduction infringes Tailte Éireann copyright

No part of this publication may be copied, reproduced or transmitted in any form or by any means without the prior written permission of the copyright owner

The representation on this map of a road, track or footpath is not evidence of the existence of a right of way

This topographic map does not show legal property boundaries, nor does it show ownership of physical features

© Tailte Éireann 2024
All rights reserved

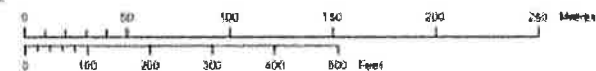

OUTPUT SCALE: 1:2,500

CAPTURE RESOLUTION
The data objects are only accurate to the resolution at which they were captured. Linear scale is not indicative of data capture scale. Further information is available at www.tailte.ie/search/Capture-Resolution

LEGEND
To view the legend and more details and search for Large Scale Legend



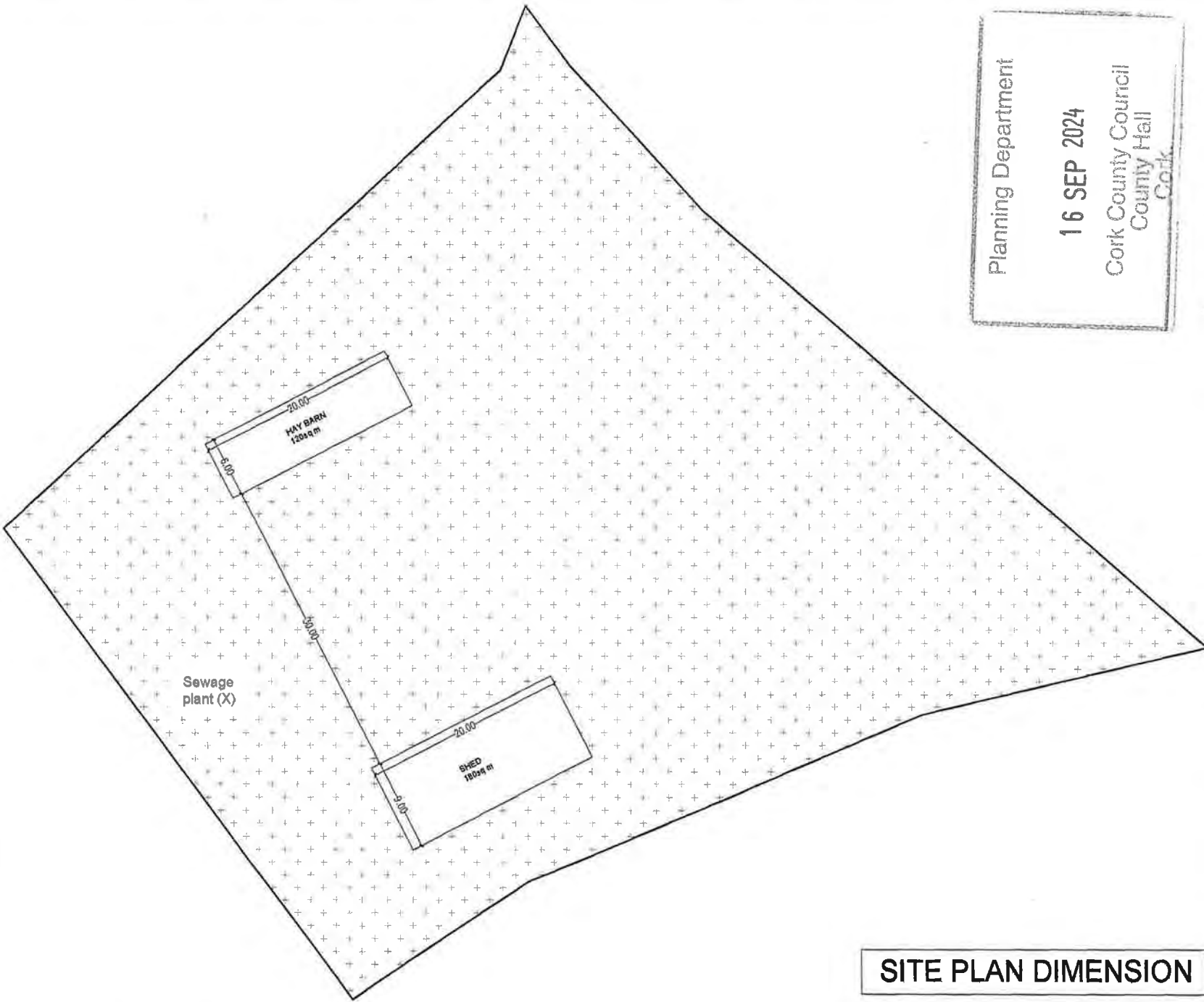

Planning Department
 16 SEP 2024
 Cork County Council
 County Hall
 Cork

SITE PLAN DIMENSION

	RCC WORK
	BRICK WORK
	POROTHERM WALL
	SOLID CONCRETE BLOCK WORK
	AAC BLOCK WORK

AREA STATEMENT

SITE AREA	10000.000 SQM
DESCRIPTION	F.F. AREA (SQM) TICH FSJ (SQM)
GROUND FLOOR	
FIRST FLOOR	
TOTAL AREA	
FB	

JOINERY SCHEDULE

TYPE	DESCRIPTION	QTY	LINTEL	SIZE
ND	MAIN DOOR	1	2400	1200 x 2400
SW	KITCHEN WINDOW	1200	2400	1200 x 1200

FOR SPECIAL NOTES

1	ENTRANCE DATE RELOCATED TO SOUTH EAST	25.05.2019
R.NO	DESCRIPTION	DATE
1	REVISIONS	

SIGN & SEAL

DRAWN BY : XXXX
 DRAWN BY : XXXX
 PROJECT : SHED
 LOCATION : XXXX
 DRAWING TITLE : Shed Floor Plan

DATE : XXXX XXXX
 SCALE : 1:1 A2 SHEET NO : 01



Planning Department
 16 SEP 2024
 Cork County Council
 County Hall
 Cork

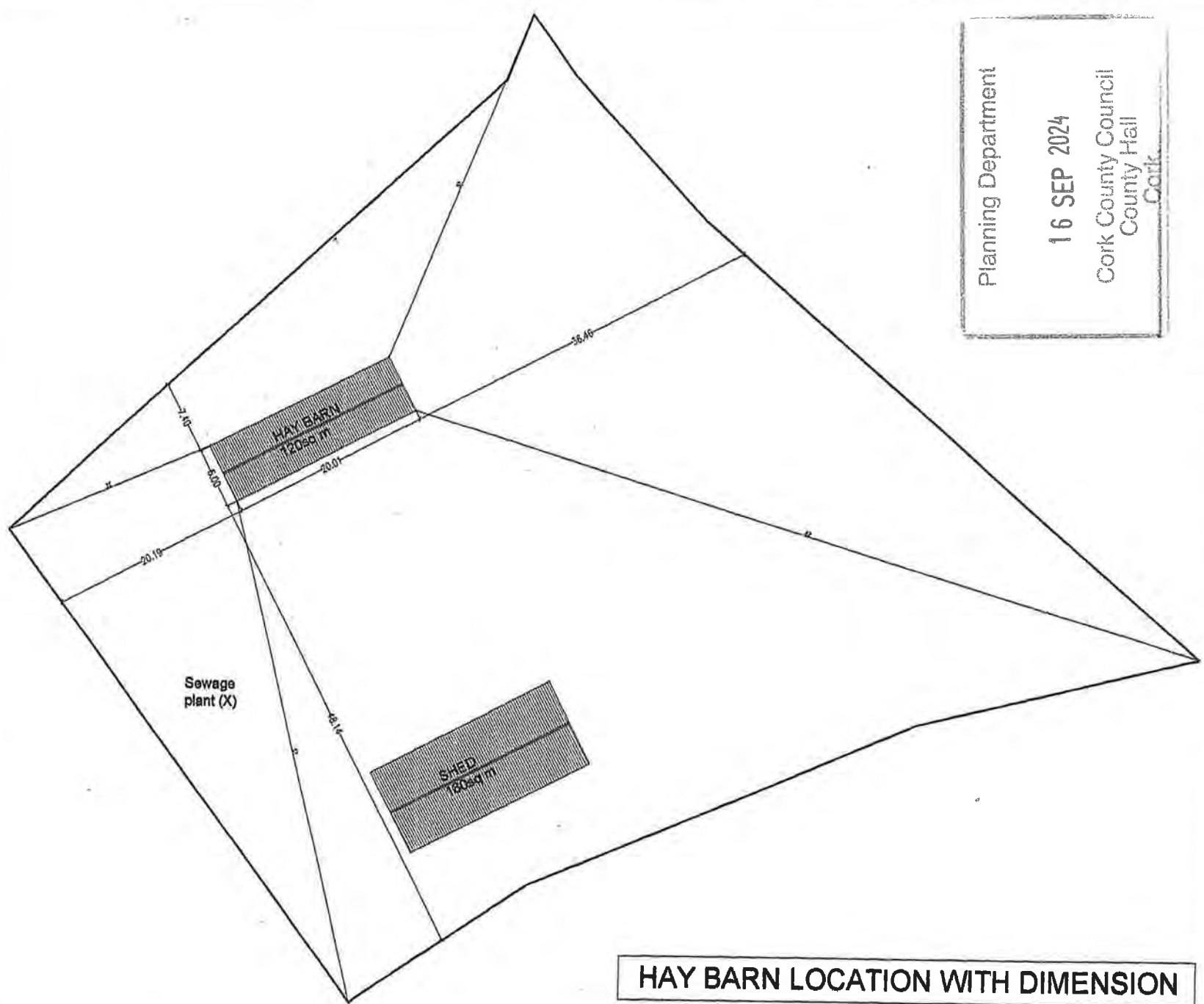

HAY BARN LOCATION WITH DIMENSION

	RCC WORK
	BRICK WORK
	POROTHERM WALL
	SOLID CONCRETE BLOCK WORK
	AAC BLOCK WORK

AREA STATEMENT

SITE AREA	1000.00 SQM		
DESCRIPTION	FBI AREA	NON FBI	
GROUND FLOOR			
FIRST FLOOR			
TOTAL AREA			
FBI			
NON FLOORAGE NO			

JOINERY SCHEDULE

TYPE	DESCRIPTION	SILL	L/INTL	SIZE
RD	RAN DOOR	-	310	1200 X 2100
RW	KITCHEN WINDOW	100	240	1000 X 1200

FOR SPECIAL NOTES

1	ENTRANCE GATE RELOCATED TO SOUTH EAST	21-08-2011
R/NO	DESCRIPTION	DATE
1	REVISIONS	

SIGN & SEAL

DRAWN BY	XXXX
DRAWN BY	XXXX
PROJECT	SHED
LOCATION	XXXX
DRAWING TITLE	Shed Floor Plan

DATE	10/09/2024
SCALE	1:1
SHEET NO	01



KEEP PLAN WITH NORTH POINT



	RCC WORK
	BRICK WORK
	POROTHERM WALL
	SOLID CONCRETE BLOCK WORK
	AAC BLOCK WORK

AREA STATEMENT

SITE AREA	: XXXX.XXX SQM
DESCRIPTION	FBI AREA / NON FBI (BLOCK)
Ground Floor	
First Floor	
Total Area	
FBI	
PLOT COVERAGE (%)	

JOINERY SCHEDULE

TYPE	DESCRIPTION	SILL	LINTEL	SIZE
MD	Main Door	-	2400	1200 X 2400
KW	Kitchen Window	1050	2400	1800 X 1350

FOR SPECIAL NOTES

R.NO	DESCRIPTION	DATE
1	Entrance gate relocated	23-05

REVISIONS

SIGN & SEAL WITH MARKS

NAME	: XXXX
REG. NO.	: XXXX
CLASS	: XXXX
PROJECT NAME	: XXXX
LOCATION	: XXXX
DRAWING TITLE	CONCEPT DRAWING GROUND FLOOR PLAN

SIGNATURE	
DATE	: XX.XX.XXXX
SCALE	: 1:500 A2 SHEET NO. : 01

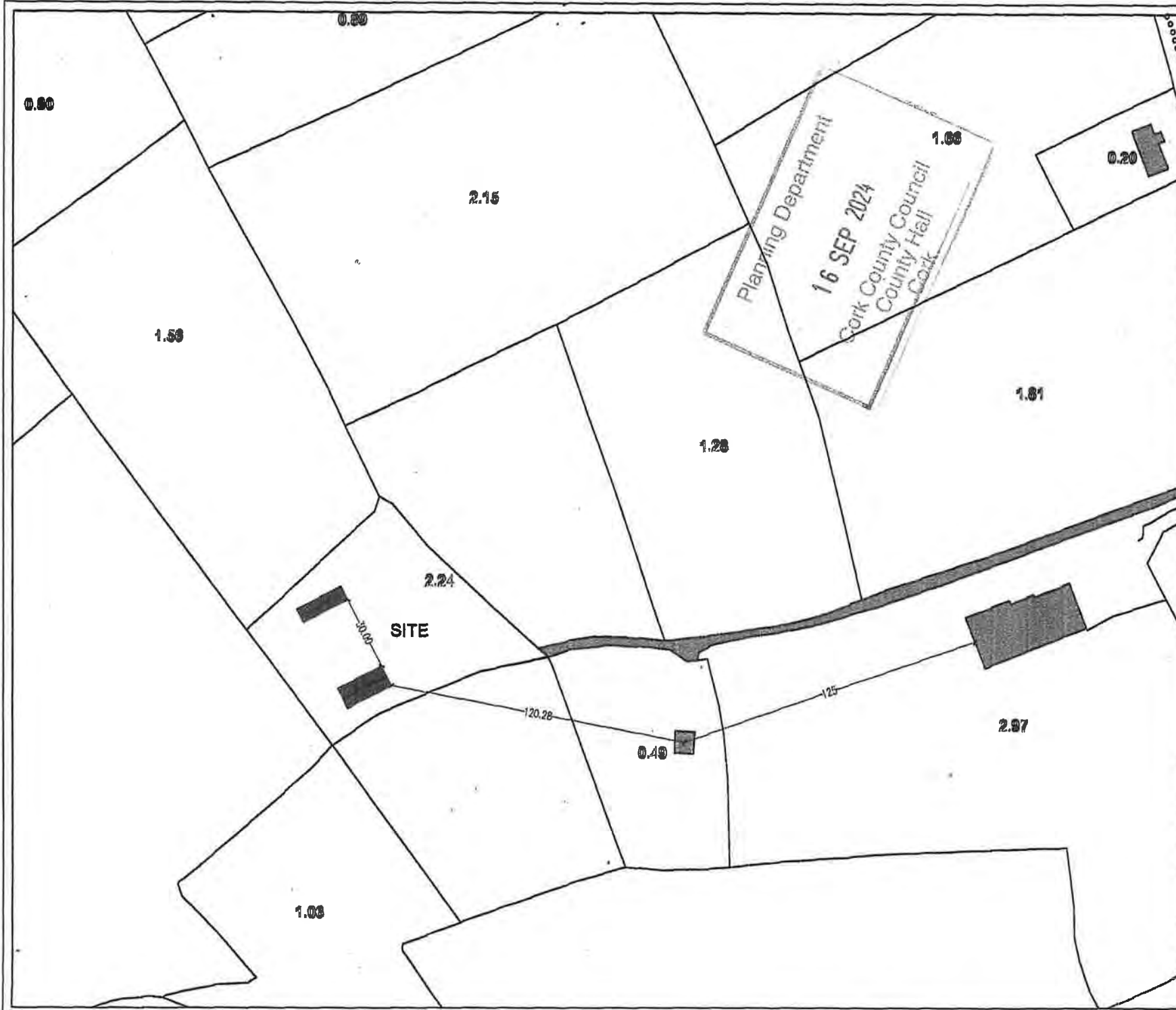

Planning Department
16 SEP 2024
Cork County Council
County Hall
Cork

Comhairle Contae Chorcaí Cork County Council

David O'Keeffe,
Ballinvuskig West,
Mourneabbey,
Co. Cork

Pleanáil agus Forbairt,
Halla an Chontae,
Bóthar Charraig Ruacháin,
Corcaigh T12 R2NC.
Fón: (021) 4276891
R-phost: planninginfo@corkcoco.ie
Suíomh Gréasáin: www.corkcoco.ie
Planning & Development,
County Hall,
Carrigrohane Road, Cork T12 R2NC.
Tel (021) 4276891
Email: planninginfo@corkcoco.ie
Web: www.corkcoco.ie



22nd August, 2024

REF: D/239/24
LOCATION: Ballinvuskig West, Mourneabbey, Co. Cork.

**RE: DECLARATION OF EXEMPTED DEVELOPMENT UNDER SECTION 5 OF THE
PLANNING & DEVELOPMENT ACT 2000 - 2010.**

Dear Sir,

On the basis of the information submitted by you on 14th June and 6th August 2024 the Planning Authority, having considered the question whether or not the construction of a shed for housing sheep at **Ballinvuskig West, Mourneabbey, Co. Cork** is or is not development and is or is not exempted development has declared that it **is development and is exempted development.**

Reason for Decision

The Planning Authority in considering this referral had particular regard to:

- Sections 2 and 3 of the Planning and Development Act 2000, (as amended),
- Article 9(1) of the Planning and Development Regulations 2001, (as amended),
- Class 6 of Part 3, Schedule 2 of the Planning and Development Regulations 2001, (as amended) and
- The particulars received by the Planning Authority on 14th June and 6th August 2024.

And Whereas Cork County Council has concluded that –

- The construction of a shed for housing sheep at **Ballinvuskig West, Mourneabbey, Co. Cork** constitutes **development which is exempted development.**

This exemption does NOT itself empower a person to carry out a development unless that person is legally entitled to do so.

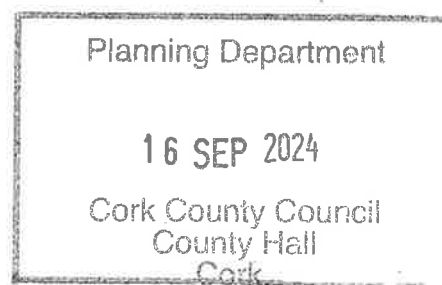

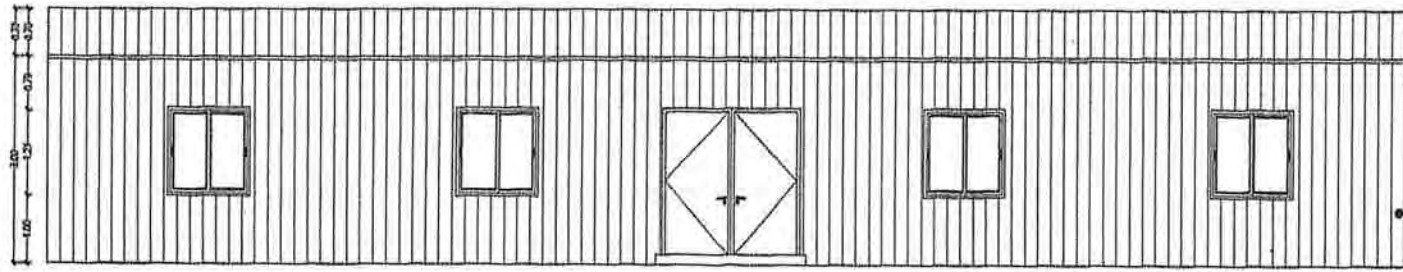

Steel sheet on concrete base

Front Elevations

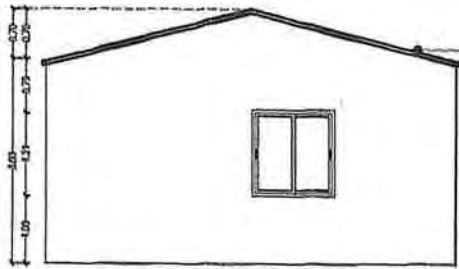

Sloped Steel sheet

Side Elevations

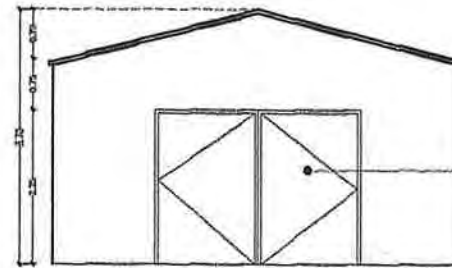

Barn door

Side Elevations

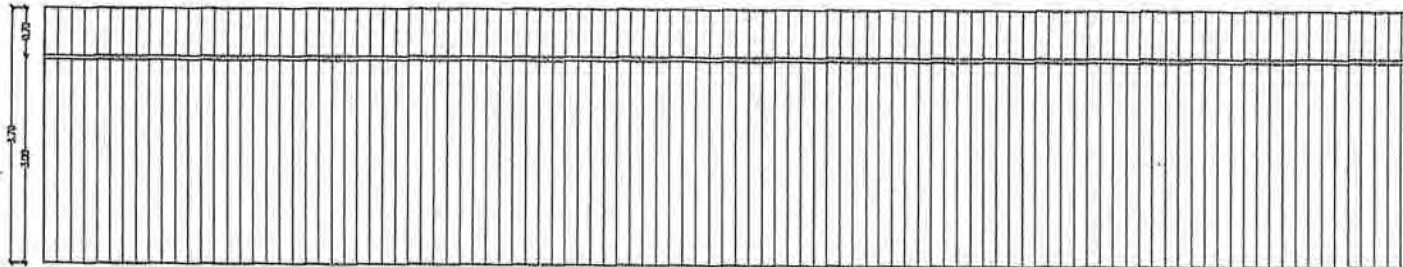

Rear Elevations

██████	RCC WORK
██████	BRICKWORK
██████	POROTHERM WALL
██████	SOLID CONCRETE BLOCK WORK
██████	AAC BLOCK WORK

AREA STATEMENT			
DESCRIPTION	FSJ AREA	NON FSJ	SI AREA
GROUND FLOOR			
FIRST FLOOR			
TOTAL AREA			
FSJ			
NOT COVERED (N)			

JOINERY SCHEDULE				
TYPI	DESCRIPTION	QTY	UNITS	SIZE
MD	MAIN DOOR		3600	1200 X 2400
WV	STORE WINDOW	1000	3600	1000 X 1500

FOR SPECIAL NOTES

NO.	DATE	DESCRIPTION	REVISIONS

ENTRANCE ONLY RELOCATED TO SOUTH EAST

SIGN & SEAL

DRAWN BY : XXXX
 DRAWN BY : XXXX
 PROJECT : SHED
 LOCATION : XXXX
 DRAWING TITLE : Shed Floor Plan

DATE : XXXX/XXX/XXXX
 SCALE : 1:1 A2 SHEET NO : 01



Planning Department
 16 SEP 2024
 Cork County Council
 County Hall

Hay Barn Elevations

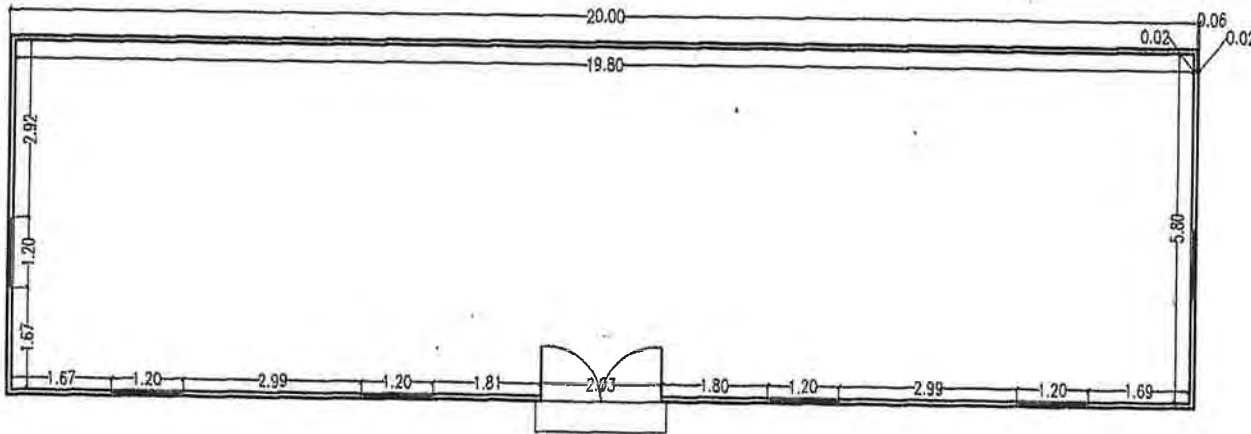
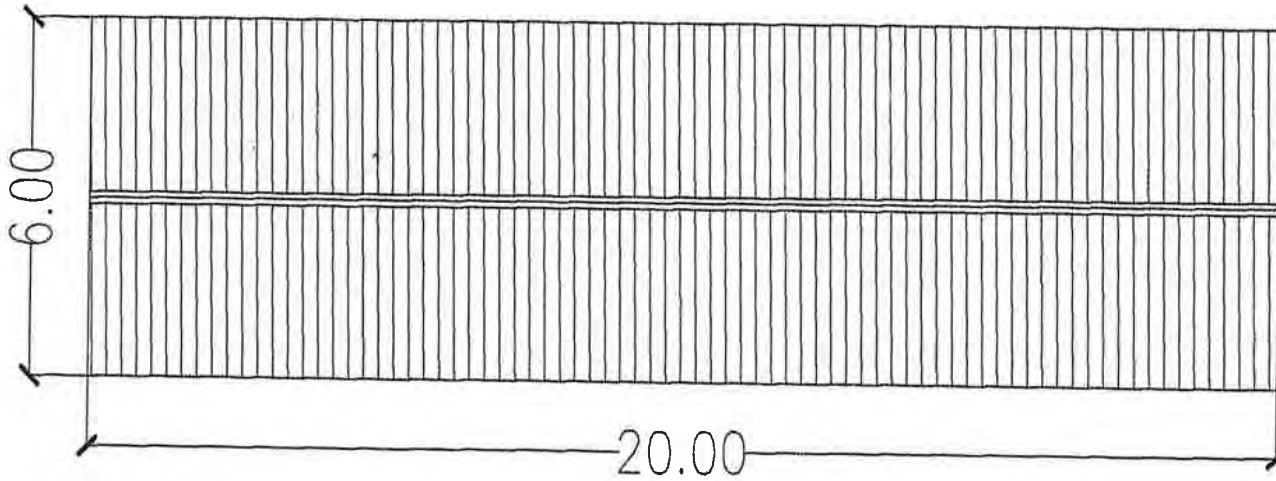

Planning Department

16 SEP 2024

Cork County Council
County Hall
Cork

SHEET NO. - 01

	RCC WORK
	BRICK WORK
	POROTHERM WALL
	SOLID CONCRETE BLOCK WORK
	AAC BLOCK WORK

AREA STATEMENT

SITE AREA DESCRIPTION	REMARKS FOR	
	PG AREA	NON PG
GROUND FLOOR		
FIRST FLOOR		
TOTAL AREA		
FT2		
PLAT COVERAGE (%)		

JOINERY SCHEDULE

NO	TYPE	DESCRIPTION	QTY	UNIT	SIZE
	MD	MAIN DOOR	1	240	1200 x 2400
	WF	WINDOOR	120	240	1500 x 1200

FOR SPECIAL NOTES

NO	DESCRIPTION	DATE
1	ENTRANCE DOOR RELOCATED TO SOUTH EAST	12/05/2014
1	REVISIONS	

SIGN & SEAL

DRAWN BY : XXXX
 DRAWN BY : XXXX
 PROJECT : SHED
 LOCATION : XXXX
 DRAWING TITLE : Shed Floor Plan

Hay Barn Plan

DATE : XX/XX/XXXX
 SCALE : 1 : 1 AS SHOWN